



WARWICK

100

SINCE 1926



# MAKING HISTORY SINCE 1926



## OUR STORY BEGINS WITH LINA.

Before we made promotional products, we were a newspaper publisher. Journalist Lina Paschal purchased *The Valley Chronicle* from her brother-in-law in 1903.



## 1926: A BRAND WAS BORN

In 1926, Lina handed the reins over to her nephew, Paul Paschal. Paul and co-owner Lester Norris started making advertising calendars when the newspaper presses weren't running. They named the calendar line "Warwick."



## 1989: COMPLETE FOCUS ON PROMOTIONAL PRODUCTS

Fourth generation co-owners Rob & Jim Paschal chose to sell our newspaper operation to focus solely on making calendars and expanding on our advertising specialty lines.

## BIGGER DEMANDS, BIGGER SPACES

We've moved a few times through the last century to accommodate both the newspaper presses and the growing demand for calendars.

## 2008: A BIG EXPANSION

With the acquisition of Winthrop-Atkins came a vast expansion in product offerings. Pocket folders, greeting cards, frames, and an even larger calendar line.



## WHERE WE ARE NOW

Wide format, ink offset, foil stamping, embossing, and a myriad of custom options, Warwick has grown. Run by fifth-generation owner Alex Paschal, we have big plans for our future, and we can't wait to share them with you.



## THANKS FOR BEING PART OF OUR STORY.

Alexander R. Paschal



# Table of Contents

## Presentation Folders & Notepads

- Ink Printed Folders ..... 7
- Foil Stamped Folders..... 8
- Small Quantity Folders ..... 9
- Budget Folders..... 10
- Embossed Folders..... 11
- Folder Styles & Business Card Die Cuts.....12-13
- Legal Folders ..... 14
- Mini Folders .....15
- Presentation Folder Paper Stocks .....16
- Horizontal Folders.....17
- Splash Folders & Padfolios.....18
- Padfolios .....19
- Jotters, Journals & Scratch Pads **NEW!** ..... 20
- Card Holders .....21
- Document Pouches, Sleeves & Envelopes **NEW!** .....22-23

## Packaging, Signs & Hangers

- Corrugated Boxes **NEW!**..... 25
- Pillow Boxes..... 26
- Tuck Boxes & Themed Packaging ..... 27
- Pen/Pencil Caddy **NEW!**..... 28
- Yard Signs **NEW!**..... 29
- Standeers **NEW!**..... 30
- Display Towers **NEW!**.....31
- Door Hangers ..... 32
- Bottle Hangers..... 33

## Photo Folders & Frames

- Golf-Themed Folders & Frames ..... 35
- Portrait & Photo Folders.....36-37
- Full-Color Photo Folders..... 38
- Coupon Gatefold Photo Folders..... 39
- Double-Sided Frames & Folders..... 40
- Paper Frames ..... 41-42
- Cardboard Frames ..... 43
- Mat Board & Bevel Frames **NEW!**..... 44-45
- Certificate Frames & Folders ..... 46-49

## Calendars

- Tri-Fold Calendars..... 51-52
- Wave Calendars ..... 53
- Table Tents & Stock Shape Waves .....54-55
- Daily Date Calendars .....56-57
- Printed Desk Calendars ..... 58
- Desk Calendars.....59-70
- Calendar Pads & Refill Pads .....71
- Trucks, Vans & Ambulances ..... 72
- Easy Stick™ Calendars ..... 73
- Value Stick™ Calendars .....74-75

## Greeting Cards

- Custom Printed Cards..... 77
- Everyday Greeting Cards ..... 78-87
- Holiday Greeting Cards.....88-91
- Hanukkah & Rosh Hashanah Cards **NEW!** ..... 92

## Reference Pages

- Artwork Requirements & General Info..... 93-94



FSC® Chain of Custody Certified since 2024.

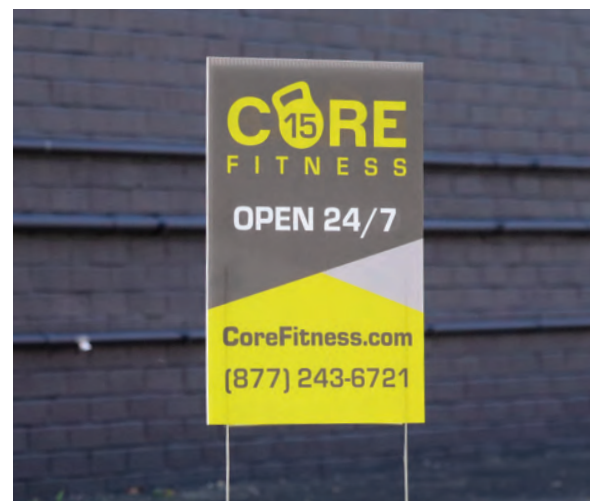



957 Imperial

## Calendar Reference

<b>024</b> Daytona .....	70	<b>423</b> Tractor Trailer .....	72	<b>955</b> Valoy .....	59
<b>041</b> Magna .....	64	<b>425</b> Long Van .....	72	<b>956</b> Princeton .....	65
<b>077</b> Pacemaker .....	69	<b>431</b> Ambulance .....	72	<b>957</b> Imperial .....	60
<b>42</b> Monarch .....	68	<b>449</b> Naples .....	64	<b>957-01DP</b> Printed Premier .....	58
<b>45</b> Stanley .....	62	<b>559</b> Genoa .....	61	<b>957-09DP</b> Printed Premier .....	58
<b>52</b> Window .....	68	<b>567</b> Emissary .....	64	<b>958</b> Budget Special .....	68
<b>53</b> Window w/Thermometer .....	65	<b>602</b> Traditional .....	74	<b>963</b> Cartwright .....	60
<b>101</b> Citation II .....	69	<b>602-50</b> Patriotic .....	74	<b>975</b> Monterey .....	63
<b>123</b> Medalist .....	70	<b>603</b> Number One .....	74	<b>984</b> Dominique .....	61
<b>125</b> Economizer .....	70	<b>604</b> House .....	75	<b>990</b> Hampshire .....	66
<b>137</b> Ace .....	62	<b>607</b> Spotlight .....	75	<b>991</b> Charter .....	61
<b>190</b> Natural .....	63	<b>613</b> Truck .....	74	<b>991-01DP</b> Printed Premier .....	58
<b>210</b> Midas .....	67	<b>614</b> Semi .....	74	<b>991-09DP</b> Printed Premier .....	58
<b>211</b> Crest .....	67	<b>615</b> Wrecker .....	75	<b>1200</b> Livingston .....	62
<b>214</b> Crown .....	67	<b>616</b> Thank You .....	74	<b>1601</b> Beach .....	52
<b>215</b> Klondike .....	67	<b>627</b> USA .....	74	<b>1603</b> USA .....	52
<b>217</b> Ambassador .....	65	<b>632</b> Circle .....	74	<b>1604</b> Scenic .....	52
<b>233</b> Norfolk .....	66	<b>633</b> Ribbon .....	74	<b>1606</b> Wildlife .....	52
<b>296</b> Mailer .....	65	<b>642</b> Crescent .....	66	<b>1607</b> Peace .....	52
<b>310</b> Perry .....	67	<b>655</b> Forest .....	63	<b>1608</b> Golf .....	52
<b>311</b> Putnam .....	67	<b>702</b> Universal .....	73	<b>1609</b> Color Block .....	52
<b>311-09DP</b> Printed Premier .....	58	<b>704</b> House .....	73	<b>1610</b> Custom Photo .....	52
<b>314</b> Madison .....	67	<b>705</b> Truck .....	73	<b>1620</b> Custom Tri-Fold .....	21
<b>315</b> Pike .....	67	<b>706</b> Horizon .....	73	<b>1801</b> Beach .....	53
<b>315-09DP</b> Printed Premier .....	58	<b>711</b> Mortar & Pestle .....	73	<b>1802</b> USA .....	53
<b>401</b> Discreet .....	62	<b>712</b> Mug .....	73	<b>1804</b> Scenic .....	53
<b>402</b> Prudent .....	69	<b>713</b> Semi Truck .....	73	<b>1808</b> Golf .....	53
<b>403</b> Vigilant .....	70	<b>756</b> Personalizer .....	66	<b>1809</b> Color Block .....	53
<b>420</b> Service Van .....	72	<b>757</b> Versailles .....	60	<b>1811</b> Peace .....	53
<b>422</b> Box Van .....	72	<b>949</b> Athens .....	68	<b>1820</b> Custom Wave .....	54

See our entire calendar collection at [WarwickPublishing.com](http://WarwickPublishing.com)

### Key



1- to 4-color  
printed imprint



1-color printed  
imprint only



Foil stamped  
imprint



Made out of or available  
in recycled material



Made out of FSC  
certified materials



**We Make It.**

American-owned business.  
American-manufactured products.



**Product shown:**  
*Style W Mini Folder, Foil Stamped (p. 15)*

## Presentation Folders & Notebooks

Ink Printed Folders .....	7	Presentation Folder Paper Stocks .....	16
Foil Stamped Folders .....	8	Horizontal Folders .....	17
Small Quantity Folders .....	9	Splash Folders & Padfolios .....	18
Budget Folders .....	10	Padfolios .....	19
Embossed Folders .....	11	Jotters, Journals & Scratch Pads .....	20
Folder Styles & Business Card Die Cuts .....	12-13	Card Holders .....	21
Legal Folders .....	14	Document Pouches & Sleeves .....	22-23
Mini Folders .....	15	Envelopes .....	23



**1-4 Color Ink Printed Presentation Folders**

- Price includes full ink coverage on front cover, back cover, and pockets
- Free aqueous coating on ink printed folders (coated papers only)
- Add Soft Touch coating or Spot Varnish. Call for a quote. Available on select paper stocks.
- Inside printing available. Call for details.



**Style:** 27 styles on p. 12-13

**Card Slits:** 9 business card die cut options (see p. 13)

**Paper:** 16 paper stock options (see p. 16)

**Imprint:** Ink offset printing with unlimited coverage (one side)

**Weight:** 12 lbs. per 100



1-Color



2-Color



3-Color



4-Color

	250	500	1000	1500	2000	2500	3000	5000
<b>1-Color Ink Printed</b>								
<b>FSPO</b> Std White Paper	3.59	2.35	1.59	1.40	1.24	1.21	1.09	0.98
<b>FCPO</b> Classic Paper	3.90	2.66	1.86	1.65	1.50	1.43	1.34	1.22
<b>FDPO</b> Designer Paper	4.54	3.27	2.40	2.20	2.01	1.93	1.82	1.65
<b>2-Color Ink Printed</b>								
<b>FSPO2</b> Std White Paper	4.43	2.83	1.86	1.59	1.43	1.37	1.24	1.19
<b>FCPO2</b> Classic Paper	4.75	3.14	2.11	1.86	1.68	1.61	1.50	1.31
<b>FDPO2</b> Designer Paper	5.39	3.78	2.66	2.40	2.20	2.11	1.96	1.76
<b>3-Color Ink Printed</b>								
<b>FSPO3</b> Std White Paper	5.45	3.38	2.20	1.86	1.62	1.55	1.40	1.22
<b>FCPO3</b> Classic Paper	5.76	3.69	2.46	2.11	1.89	1.79	1.65	1.46
<b>FDPO3</b> Designer Paper	6.40	4.30	2.99	2.66	2.40	2.29	2.11	1.89
<b>4-Color Ink Printed</b>								
<b>FSPO4</b> Std White Paper	8.09	4.48	2.50	1.98	1.70	1.59	1.44	1.31
<b>FCPO4</b> Classic Paper	8.42	4.78	2.77	2.25	1.96	1.85	1.70	1.55
<b>FDPO4</b> Designer Paper	9.05	5.40	3.30	2.78	2.47	2.35	2.17	1.98

8C. Soft Touch coating is available. Call for a quote. Not available on some papers.

# Presentation Folders | Foil Stamped Folders

## 1-2 Color Foil Stamped Presentation Folders

- Available in all 57 paper stocks (see p. 16)
- No set-up charges!
- 1- or 2-color imprint



**Style:** 27 styles on p. 12-13

**Card Slits:** 9 business card die cut options (see p. 13)

**Paper:** 57 paper stock options (see p. 16)

**Imprint:** 5" x 6" or up to 30 sq. inches (per color)

**Weight:** 12 lbs. per 100



## Imprint Locations

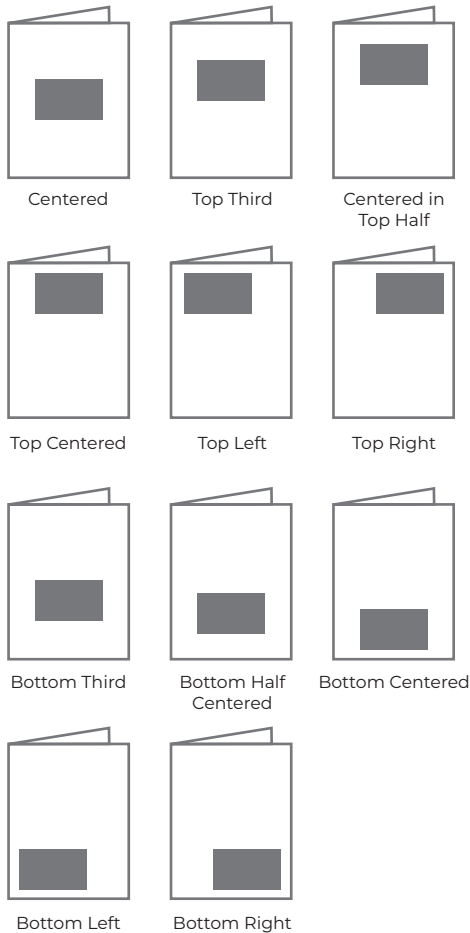

1-Color Foil (left) and 2-Color Foil (right)

		250	500	1000	1500	2000	2500	3000	5000
<b>1-Color Foil Stamped</b>									
<b>FSP</b>	Std White Paper	3.04	2.14	1.70	1.55	1.44	1.40	1.34	1.24
<b>FCP</b>	Classic Paper	3.57	2.47	2.04	1.92	1.79	1.73	1.68	1.61
<b>FDP</b>	Designer Paper	3.79	2.98	2.47	2.35	2.25	2.17	2.11	2.01
<b>2-Color Foil Stamped</b>									
<b>FSP2</b>	Std White Paper	4.43	3.14	2.44	2.05	1.89	1.79	1.70	1.56
<b>FCP2</b>	Classic Paper	4.85	3.51	2.86	2.53	2.35	2.23	2.08	1.93
<b>FDP2</b>	Designer Paper	5.42	4.14	3.30	2.83	2.66	2.53	2.43	2.29

# Presentation Folders | Small Quantity Folders



## Small Quantity Presentation Folders

- Popular Style A at a 50 folder minimum



**Style:** 9" x 12" (Style A) with two 4" pockets  
**Card Slits:** Standard Business Card die cuts on right pocket  
**Paper:** Choose from 11 paper stock options (see below)  
**Imprint:** 3" x 5" or up to 15 square inches. Front cover, one location only. See below for imprint locations.  
**Foil:** 1-color metallic foil imprint: Bright Gold, Bright Silver, Blue, Red, or Green, plus non-metallic White or Black  
**Weight:** 12 lbs. per 100

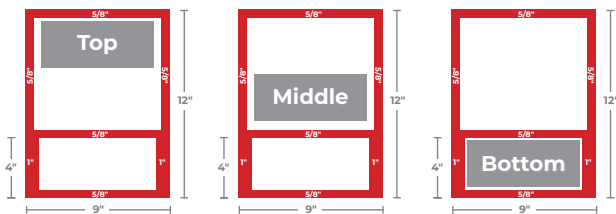

Gray boxes are designated imprint areas. Red area cannot be foil stamped.

### Standard White Paper – FSP-SQ



### Classic Paper – FCP-SQ

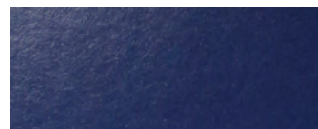

Blue Gloss



Burgundy Gloss

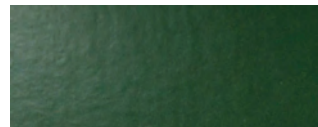

Green Gloss



Black Gloss



Red Gloss

### Designer Paper – FDP-SQ

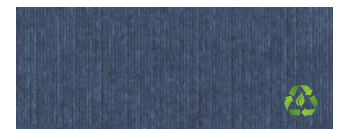

Blue Linen

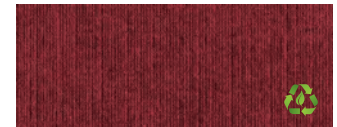

Burgundy Linen

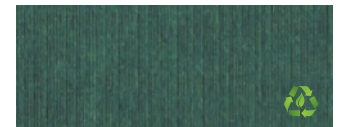

Green Linen



Ivory Linen



Black Linen

Small Quantity	50	100	150	200–249
<b>FSP-SQ</b> Std White Paper	5.40	4.21	3.81	3.63
<b>FCP-SQ</b> Classic Paper	5.94	4.75	4.35	4.15
<b>FDP-SQ</b> Designer Paper	6.16	4.97	4.57	4.39

4C. For quantities of 250 or higher, see page 8.

# Presentation Folders | Budget Folders

## Budget Presentation Folders 1-Color Ink or Foil

**Style:** 9" x 12" ( Style A) with two 4" pockets

**Paper:** Standard white stock (C1S only)

**Card Slits** Standard Business Card die cuts, right pocket only

**Imprint:** Ink offset printed or foil stamped. 3" x 5" or up to 15 square inches. One location, one color. Free aqueous coating on printed budget folders (no bleed).

**Weight:** 12 lbs. per 100



FESO – Budget Ink

Budget Folders		250	500	1000	1500	2000	2500	3000	5000
<b>FES</b>	Foil Stamped	2.71	1.68	1.34	1.15	1.04	1.01	0.89	0.76
<b>FESO</b>	Printed	3.17	2.10	1.50	1.29	1.13	1.04	0.91	0.76

8C



FES – Budget Foil

### Imprint Locations

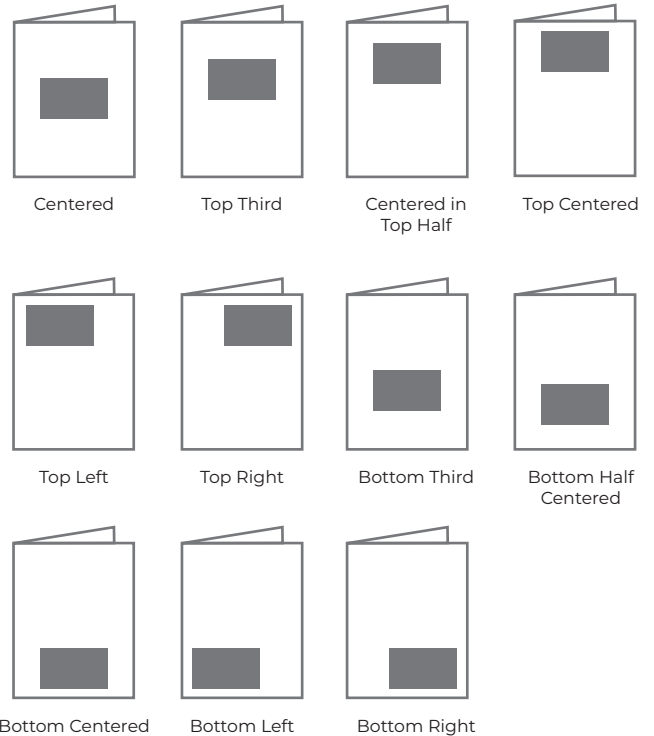



Style A – Burgundy Felt paper stock

### **Blind Embossing**

This is our most affordable and popular option. Blind embossing means your image is simply raised off the paper one flat level—without any extra foil or printed artwork. It's a subtle effect that works well for any logo.

.....

### **Reverse-Outs**

We can emboss reversed-out logos and artwork, but avoid fine details, as those might not transfer.

.....

### **Artwork Size & Complexity**

Your price depends largely on the size and complexity of your artwork. For instance, small, complex logos can cost more than a slightly larger, yet simpler logo.

.....

### **Pick an Appropriate Paper Stock**

The complexity of your artwork will dictate the paper stock you can use. Logos with fine details show best on smooth or glossy paper stock. While you can emboss on any stock, fine details might be lost on textured papers like black weave or corduroy.

## **How to order embossed folders**

**Please contact us to receive a quote on your embossed folders.**

We will determine the cost of your embossed folders based on the criteria listed here.



Style XZ – Blue Smooth paper stock

# Presentation Folders | Standard Folder Styles

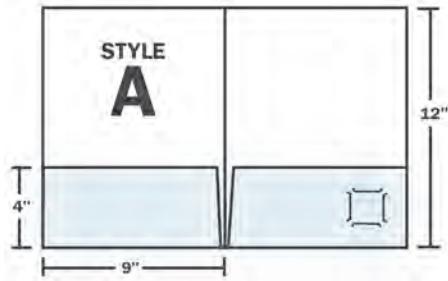

**9" x 12" Standard Folder**

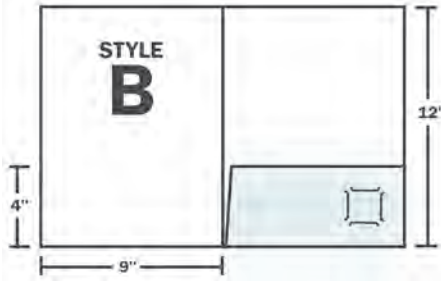

**9" x 12" One Pocket Folder**

Left side single pocket available upon request

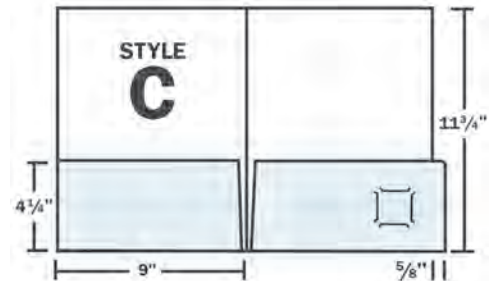

**9" x 11-3/4" File Tab Folder**

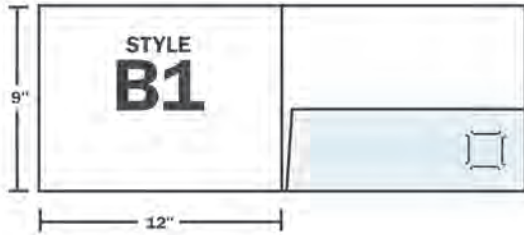

**12" x 9" One Pocket Landscape Folder**

Left or right side single pocket  
Not available in these papers: corduroy; gray or burgundy linen; burgundy felt.

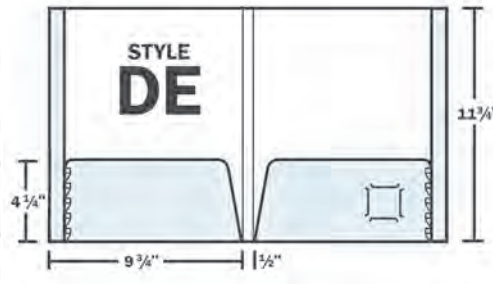

**9-3/4" x 11-3/4" Reinforced, Expandable Folder**

Spine measures 1/2"

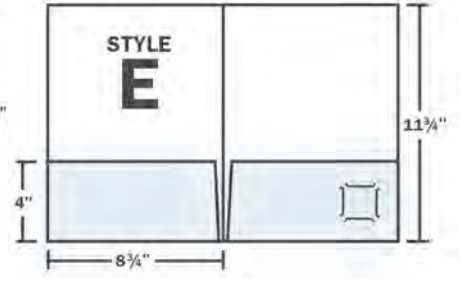

**8-3/4" x 11-3/4" Folder**

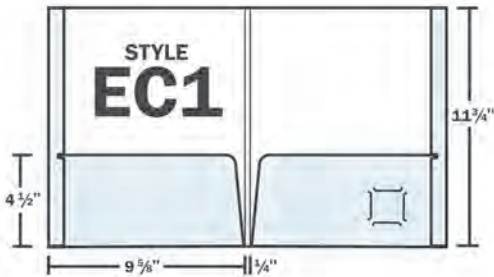

**9-5/8" x 11-3/4" Reinforced Folder**

Spine measures 1/4"

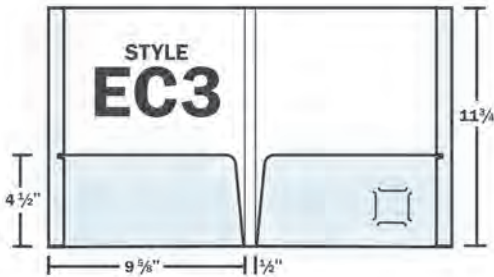

**9-5/8" x 11-3/4" Reinforced Folder**

Spine measures 1/2"

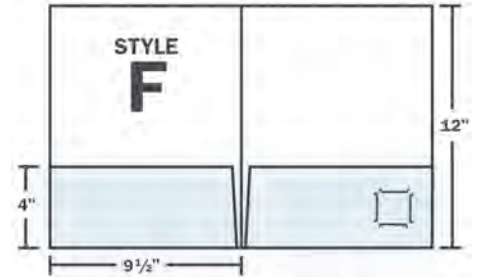

**9-1/2" x 12" Folder**



**11-7/8" x 9" File Folder**

Tab available Left, Center, or Right

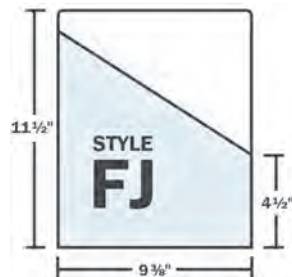

**9-3/8" x 11-1/2" File Jacket Folder**

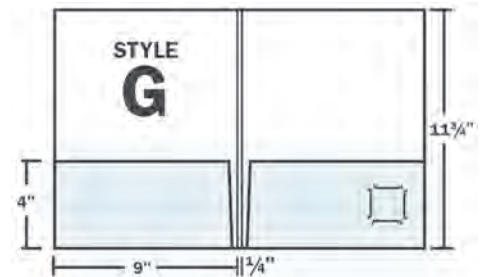

**9" x 11-3/4" with 1/4" Spine Folder**

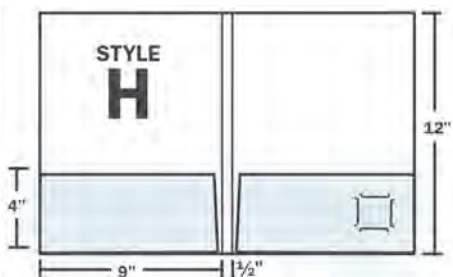

**9" x 12" with 1/2" Spine Folder**

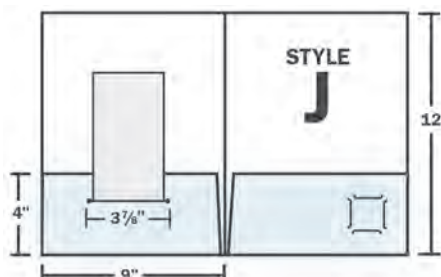

**9" x 12" Brochure Folder**

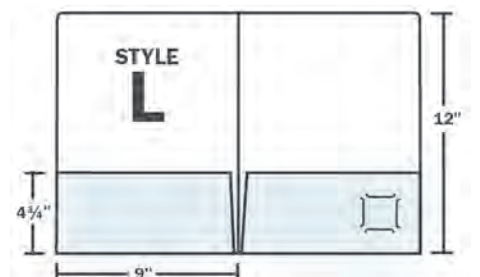

**9" x 12" Round Corner Edge Folder**

# Presentation Folders | Standard Folder Styles

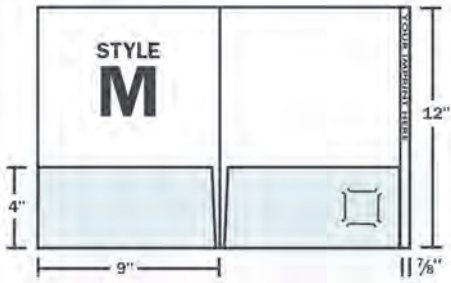

**9-3/4" x 12" Full Tab Folder**

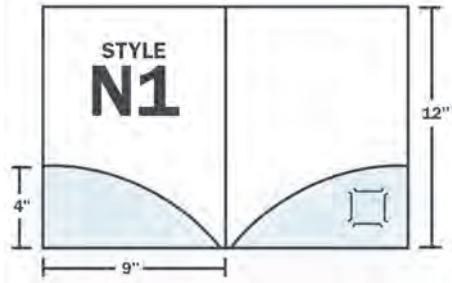

**9" x 12" Curved Pocket Folder**

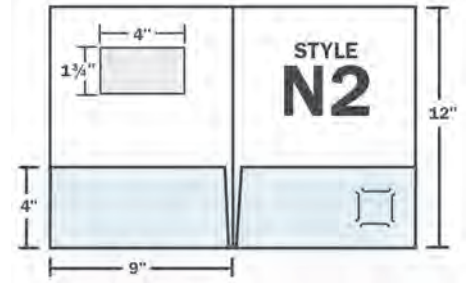

**9" x 12" Window Folder**  
Alternate window sizes available.

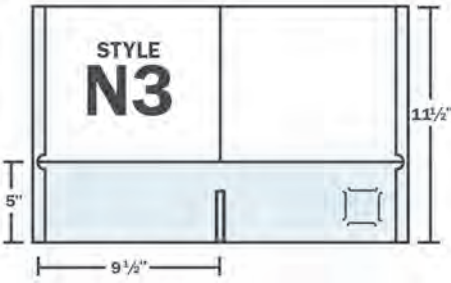

**9-1/2" x 11-1/2" Continuous Reinforced Pocket Folder**

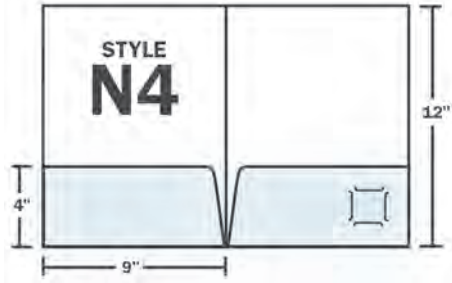

**9" x 12" Folder with Round Corner Pockets**

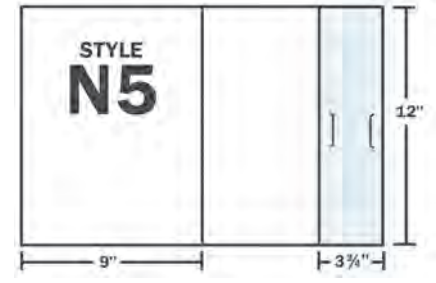

**9" x 12" Single Vertical Pocket Folder**  
Accommodates a vertical business card

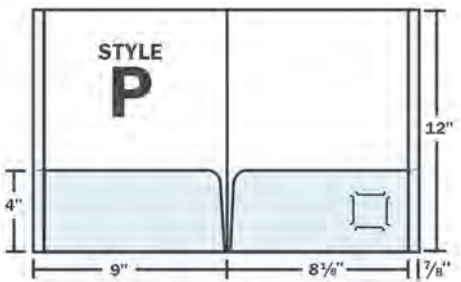

**9" x 12" Reinforced Folder**

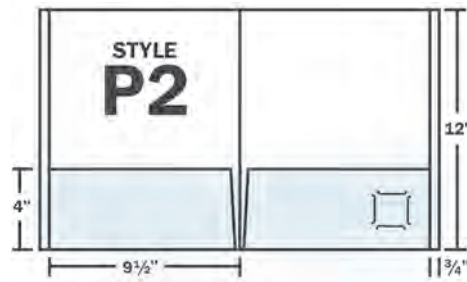

**9-1/2" x 12" Large Reinforced Folder**

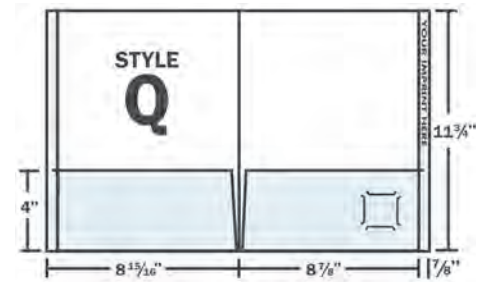

**9-3/4" x 11-3/4" Reinforced Full Tab Folder**

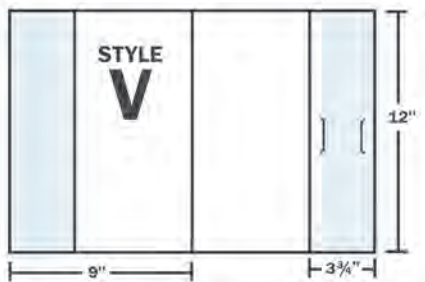

**9" x 12" Vertical Pocket Folder**

*Not available in these papers: corduroy; gray or burgundy linen; burgundy felt.*

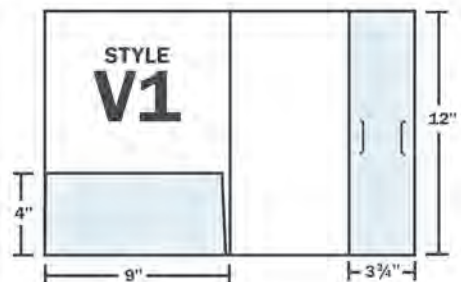

**9" x 12" Dual Pocket Folder**

Left horizontal pocket, right vertical pocket  
*Business card slits available on either pocket.  
Also available with a left vertical pocket,  
right horizontal pocket (Style V2)*

## Business Card Die Cut Options

Please specify right, left, or both pockets when ordering. Standard business card die cuts will be used if not specified on the order. **Custom business card die cuts are available.** Please inquire for details. Additional charges may apply.



1. Standard



2. Standard Center



3. 2-Slit Right



4. 2-Slit Center



5. Half-Moon Center



6. 4-Slit Right



7. 4-Slit Center



8. No Slits



Vertical Slits

**Flash drive slits available**

## Legal-Size Presentation Folders

**Style:** 9" x 14-3/4" Style T folder

**Card Slits:** 9 business card die cut options (see p. 13)

**Paper:** 57 papers (foil); 16 papers (ink). See p. 16

**Foil Imprint:** 5" x 6" or up to 30 sq. inches

**Ink Imprint:** Unlimited coverage, printed on the front, back, and pockets. Call for additional print options.



- Free aqueous coating on ink printed folders (coated papers only)
- Add Soft Touch coating or Spot Varnish. Call for a quote. Available on select paper stock.



## Ink Printed Folder Pricing

### 1-Color Ink Printed 250 500 1000 1500 2000 2500 3000 5000

<b>FLSPO</b> Std White Paper	3.87	2.63	1.88	1.68	1.52	1.49	1.37	1.27
<b>FLCPO</b> Classic Paper	4.18	2.95	2.14	1.94	1.79	1.71	1.62	1.50
<b>FLDPO</b> Designer Paper	4.82	3.56	2.68	2.49	2.29	2.22	2.10	1.93

### 2-Color Ink Printed 250 500 1000 1500 2000 2500 3000 5000

<b>FLSPO2</b> Std White Paper	4.72	3.11	2.14	1.88	1.71	1.65	1.52	1.47
<b>FLCPO2</b> Classic Paper	5.03	3.42	2.40	2.14	1.96	1.89	1.79	1.59
<b>FLDPO2</b> Designer Paper	5.67	4.06	2.95	2.68	2.49	2.40	2.25	2.04

### 3-Color Ink Printed 250 500 1000 1500 2000 2500 3000 5000

<b>FLSPO3</b> Std White Paper	5.73	3.66	2.49	2.14	1.91	1.83	1.68	1.50
<b>FLCPO3</b> Classic Paper	6.04	3.97	2.74	2.40	2.17	2.07	1.94	1.74
<b>FLDPO3</b> Designer Paper	6.68	4.58	3.27	2.95	2.68	2.57	2.40	2.17

### 4-Color Ink Printed 250 500 1000 1500 2000 2500 3000 5000

<b>FLSPO4</b> Std White Paper	8.38	4.76	2.78	2.26	1.98	1.88	1.73	1.59
<b>FLCPO4</b> Classic Paper	8.71	5.06	3.05	2.53	2.25	2.13	1.98	1.83
<b>FLDPO4</b> Designer Paper	9.33	5.68	3.59	3.07	2.75	2.63	2.46	2.26

## Foil Stamped Folder Pricing

### 1-Color Foil Stamped 250 500 1000 1500 2000 2500 3000 5000

<b>FLSP</b> Std White Paper	3.32	2.43	1.98	1.83	1.73	1.68	1.62	1.52
<b>FLCP</b> Classic Paper	3.85	2.75	2.32	2.20	2.07	2.01	1.96	1.89
<b>FLDP</b> Designer Paper	4.08	3.26	2.75	2.63	2.53	2.46	2.40	2.29

### 2-Color Foil Stamped 250 500 1000 1500 2000 2500 3000 5000

<b>FLSP2</b> Std White Paper	4.72	3.42	2.72	2.34	2.17	2.07	1.98	1.85
<b>FLCP2</b> Classic Paper	5.13	3.80	3.14	2.81	2.63	2.52	2.37	2.22
<b>FLDP2</b> Designer Paper	5.70	4.42	3.59	3.11	2.95	2.81	2.71	2.57

All legal pocket folders are 8C.

**Paper Stock Note:** Printed legal folders are available in select paper stocks only. See page 16 for papers that can be printed. Look for this symbol:



1-Color Foil (left) and 2-Color Foil (right)



**Style XZ – FMSP0**  
4-Color Process

**Mini Presentation Folders**

**Style:** Styles U, W, XZ, or Y

**Card Slits:** See business card die cut options below

**Weight:** 6 lbs. per 100



OPTIONS

**Digitally Printed Mini Folders**



**Paper:** Standard white, coated one side

**Imprint:** 1–4 colors on front, back, and pockets



1-Color Foil

2-Color Foil

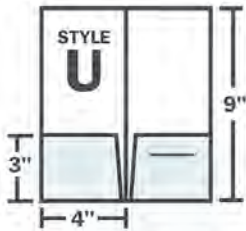

**4" x 9" Pocket Folder**

Right side slot holds room keys and gift cards. Fits in a #10 envelope.

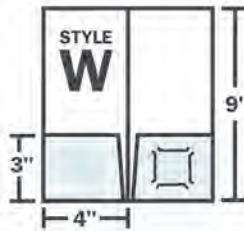

**4" x 9" Pocket Folder**

Standard business card slits only. Fits in a #10 envelope.

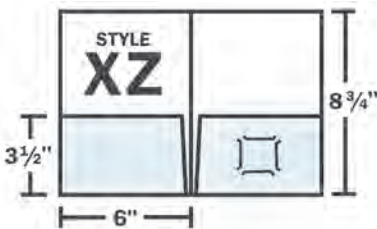

**6" x 8-3/4" Pocket Folder**

Standard business card slits only.

**Foil Stamped Mini Folders**

**Paper:** 57 paper stock options (see p. 16)

**Imprint:** 4" x 5" or up to 20 sq. inches (Styles XZ & Y)  
3" x 4" or up to 12 sq. inches (Styles U & W)

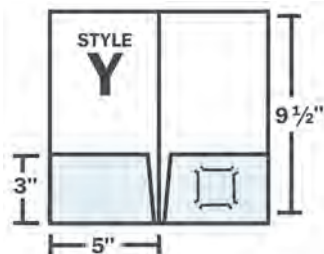

**5" x 9-1/2" Pocket Folder**

Standard or Half-Moon business card slits only.

**Digitally Printed**    **250**    **500**    **1000**    **1500**    **2000**    **2500**    **3000**    **5000**

<b>FMSP0</b> Std White Paper	2.85	2.48	2.15	2.00	1.96	1.93	1.90	1.86
------------------------------	------	------	------	------	------	------	------	------

8C. Inside printing available for \$0.40 (C) each.

**1-Color Foil Stamped**    **250**    **500**    **1000**    **1500**    **2000**    **2500**    **3000**    **5000**

<b>FMSP</b> Std White Paper	2.52	1.41	0.95	0.81	0.74	0.73	0.64	0.55
-----------------------------	------	------	------	------	------	------	------	------

<b>FMCP</b> Classic Paper	2.71	1.56	1.10	0.93	0.86	0.84	0.77	0.68
---------------------------	------	------	------	------	------	------	------	------

<b>FMDP</b> Designer Paper	2.77	1.58	1.11	0.98	0.87	0.86	0.78	0.70
----------------------------	------	------	------	------	------	------	------	------

**2-Color Foil Stamped**    **250**    **500**    **1000**    **1500**    **2000**    **2500**    **3000**    **5000**

<b>FMSP2</b> Std White Paper	3.52	2.15	1.66	1.44	1.18	1.14	1.02	0.90
------------------------------	------	------	------	------	------	------	------	------

<b>FMCP2</b> Classic Paper	3.73	2.30	1.81	1.56	1.30	1.26	1.16	1.04
----------------------------	------	------	------	------	------	------	------	------

<b>FMDP2</b> Designer Paper	3.79	2.32	1.82	1.58	1.32	1.27	1.17	1.05
-----------------------------	------	------	------	------	------	------	------	------

8C

# Presentation Folders | Folder Stock

## Standard White Paper



**SMTH01**  
White Gloss  
12 pt. C1S

## Classic Papers

Classic papers have white inside panels. Soft Touch available on Standard and Classic papers except for Black Weave, Corduroy, and Smooth.

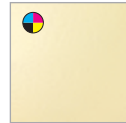

**SMTH11**  
Ivory Gloss  
12 pt. C1S



**SMTH06**  
Red Gloss  
12 pt. C1S

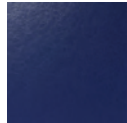

**SMTH05**  
Blue Gloss  
12 pt. C1S



**SMTH07**  
Burgundy Gloss  
12 pt. C1S



**SMTH04**  
Green Gloss  
12 pt. C1S

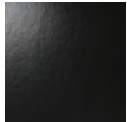

**SMTH09**  
Black Gloss  
12 pt. C1S



**SMTH35**  
Pink Gloss  
12 pt. C1S



**SMTH37**  
Purple Gloss  
12 pt. C1S



**SMTH36**  
Orange Gloss  
12 pt. C1S



**SMTH10**  
Yellow Gloss  
12 pt. C1S



**MARB04**  
Green Marble  
12 pt. C1S



**MARB05**  
Blue Marble  
12 pt. C1S

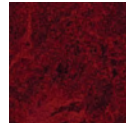

**MARB07**  
Burgundy Marble  
12 pt. C1S



**MARB03**  
Charcoal Marble  
12 pt. C1S



**SMTHMT23**  
Silver Metallic  
12 pt. C1S



**SMTHMT34**  
Blue Metallic  
12 pt. C1S



**SMTHMT04**  
Green Metallic  
12 pt. C1S



**WAFF09**  
Black Weave  
20 pt. Textured Stock



**CORD01**  
White Corduroy  
12 pt. C1S



**CORD11**  
Ivory Corduroy  
12 pt. C1S



**CORD06**  
Red Corduroy  
12 pt. C1S



**CORD04**  
Green Corduroy  
12 pt. C1S



**CORD05**  
Blue Corduroy  
12 pt. C1S



**CORD07**  
Burgundy Corduroy  
12 pt. C1S



**CORD09**  
Black Corduroy  
12 pt. C1S



**C2S01**  
White Gloss  
12 pt. C2S

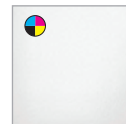

**LSTRD01**  
White Dull  
12 pt. C2S



**SMTH01-14**  
White Gloss  
14 pt. C1S

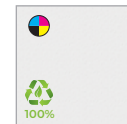

**SMUN01**  
White Smooth  
100# Uncoated Cover

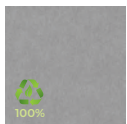

**SMUN23**  
Silver Smooth  
100# Uncoated Cover

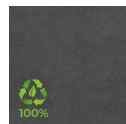

**SMUN09**  
Black Smooth  
100# Uncoated Cover



**SMUN05**  
Blue Smooth  
100# Uncoated Cover



**SMUN04**  
Green Smooth  
100# Uncoated Cover

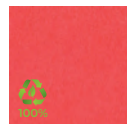

**SMUN06**  
Red Smooth  
100# Uncoated Cover



**SMUN07**  
Burgundy Smooth  
100# Uncoated Cover

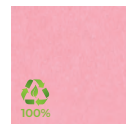

**SMUN35**  
Pink Smooth  
100# Uncoated Cover

percentage denotes post-consumer waste content

## Paper Stock Notes

All papers can be foil stamped or embossed.

Paper stocks available for printing are specified with this icon:

Any ink printed on paper other than white may appear a different shade.

Colors shown here are printed reproductions, and may vary slightly from the actual product. Email or call to request physical samples.

## Designer Papers

Soft Touch not available on Designer Papers



**HIGL01**  
White Hi-Gloss  
12 pt. C1S



**SPEM01**  
White Leatherette  
12 pt. C1S



**LAID01**  
White Laid  
80# Cover

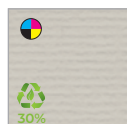

**LAID03**  
Gray Laid  
80# Cover

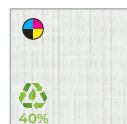

**LINN01**  
White Linen  
100# Cover

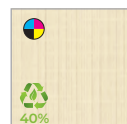

**LINN11**  
Ivory Linen  
100# Cover



**LINN03**  
Gray Linen  
100# Cover



**LINN04**  
Green Linen  
100# Cover



**LINN05**  
Blue Linen  
100# Cover

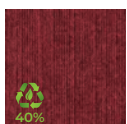

**LINN07**  
Burgundy Linen  
100# Cover



**LINN09**  
Black Linen  
100# Cover



**FELT01**  
White Felt  
100# Cover

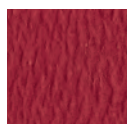

**FELT06**  
Red Felt  
94# Cover



**FELT09**  
Black Felt  
100# Cover



**FELT07**  
Burgundy Felt  
100# Cover

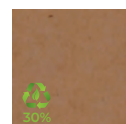

**FIBRKT**  
Kraft Fiber  
80# Cover



**LTHR01**  
White Leatherette  
90# Cover



**LTHR05**  
Blue Leatherette  
90# Cover



**LTHR04**  
Green Leatherette  
90# Cover



**LTHR09**  
Black Leatherette  
90# Cover



N6M-DP

**Printed Horizontal Presentation Folders**

- Small size is perfect for marketing kits or event giveaway packets
- Digitally printed in full color
- Printed on front cover, back cover, and pocket



**Size:** 6-1/8" x 8-1/2" with 2-1/4" pocket  
**Stock:** Smooth white cardstock  
**Imprint:** 4-color process  
**Weight:** 5 lbs. per 100

Horizontal Folders	150	250	500	1000	1750	2500
<b>N6M-DP</b>	4.38	3.69	3.14	2.71	2.39	2.11

6C

**Foil Stamped Horizontal Presentation Folders**

- Choose Mini or Standard
- Business card die cuts on Standard only
- Perfect for marketing packs, folios, or sales kits



**N6M Mini Folder**

**Size:** 6-1/8" x 8-1/2" with 2-1/4" pocket  
**Imprint:** 4" x 5" or up to 20 sq. inches  
**Weight:** 5 lbs. per 100



N6M Mini Folder

N6 Standard Folder

**N6 Standard Folder**

**Size:** 9" x 12" with 3-3/4" pocket  
**Imprint:** 5" x 6" or up to 30 sq. inches  
**Weight:** 11 lbs. per 100



Horizontal Folders	250	500	1000	1500	2000	2500	3000	5000
<b>N6M</b> Mini	2.78	1.59	1.12	0.98	0.88	0.86	0.78	0.70
<b>N6</b> Standard	3.80	2.98	2.48	2.35	2.24	2.18	2.12	2.01

8C

Award-winning promotional products supplier

# Presentation Folders | Splash Folders & Padfolios

## Splash Folders

- 12 pt. stock coated on interior and exterior
- Interior matches front color curve
- Pockets are black



**Size:** 9" x 12" (Style N1)

**Pocket:** 4" curved pockets. Standard Business Card die cut on right pocket

**Imprint:** 5" x 6" or up to 30 sq. inches. One location.  
*Other colors available upon request.*

**Imprint Color:** Matching imprint colors standard. Gold or Silver upon request.

**Weight:** 12 lbs. per 100



SPLASH1 – 1-Color Foil  
*(2-color foil available, SPLASH2)*

Splash Folders	250	500	1000	1500	2000	2500	3000	5000
<b>SPLASH1</b> Mini	3.82	2.87	2.37	2.11	1.90	1.71	1.65	1.58
<b>SPLASH2</b> Standard	5.01	3.66	2.69	2.31	2.11	1.90	1.77	1.65

8C



**SPL-AP**  
Apricot

**SPL-PK**  
Pink Lemonade

**SPL-BY**  
Berry

**SPL-PL**  
Plum

**SPL-MG**  
Mango

**SPL-LM**  
Lime

**SPL-CH**  
Cherry



F949-SPL1

F938-SPL1

## Splash Padfolios

- Mini or Large padfolios
- Matching imprint colors standard
- Gold or Silver imprint available upon request
- 20-sheet lined notepad



### 938 Mini Splash Padfolios

**Size:** 6-1/2" x 9-1/2", Pad Size 6" x 9"

**Imprint:** 3" x 5" or up to 15 sq. inches, one location

**Weight:** 25 lbs. per 100

### 949 Large Splash Padfolios

**Size:** 9-1/2" x 11-3/4", Pad Size 8-1/2" x 10-7/8"

**Imprint:** 5" x 6" or up to 30 sq. inches, one location

**Weight:** 35 lbs. per 100

Splash Padfolios	150	250	500	1000	1500	2000	2500
<b>F938-SPL1</b> Mini – 1 Color Foil	3.89	3.32	3.04	2.94	2.86	2.78	2.71
<b>F949-SPL1</b> Lg – 1 Color Foil	6.09	4.96	4.79	4.63	4.50	4.37	4.18
<b>Add'l Foil</b> Mini & Lg	1.47	1.15	0.99	0.75	0.67	0.59	0.47

7C



938

**Printed Padfolios**

- Great for schools, training programs, corporate meetings, trade shows, and more.
- Choose standard padfolio (938) or padfolios with pen holder slits (926). Pens not included.
- Folio flap is not glued



**Size:** 6-1/2" x 9-1/2"

**Pad Size:** 6" x 9"

**Imprint:** 4-color process on front, back & flap

**Pad:** 20-sheet lined notepad

**Folio Flap:** Horizontal business card slits

**Weight:** 2 lbs. per 100



926  
with pen holder

Printed Padfolios	150	250	500	1000	1500	2000	2500
<b>938, 926</b> Full Color	4.35	3.97	3.64	3.51	3.45	3.42	3.39

7C. Inside cover printing available for \$0.40 (C) each.

**Foil Stamped Classic Padfolios**

- Mini or Large with 20-sheet lined notepad
- Horizontal business card slits on folio flap
- Gold, Silver, or White foil imprint. Other colors available upon request.
- Folio flap is not glued.



**F938 Mini Classic Padfolios**

**Size:** 6-1/2" x 9-1/2", Pad Size 6" x 9"

**Imprint:** 3" x 5" or up to 15 sq. inches, one location

**Weight:** 25 lbs. per 100



F938



F949



**F949 Large Classic Padfolios**

**Size:** 9-1/2" x 11-3/4", Pad Size 8-1/2" x 10-7/8"

**Imprint:** 5" x 6" or up to 30 sq. inches, one location

**Weight:** 35 lbs. per 100

**Classic Padfolios**

Classic Padfolios	150	250	500	1000	1500	2000	2500
<b>F938</b> Mini – 1 Color Foil	3.89	3.32	3.04	2.94	2.86	2.78	2.71
<b>F949</b> Lg – 1 Color Foil	6.09	4.96	4.79	4.63	4.50	4.37	4.18
<b>Add'l Foil</b> Mini & Lg	1.47	1.15	0.99	0.75	0.67	0.59	0.47

7C

**Classic Padfolio Colors**

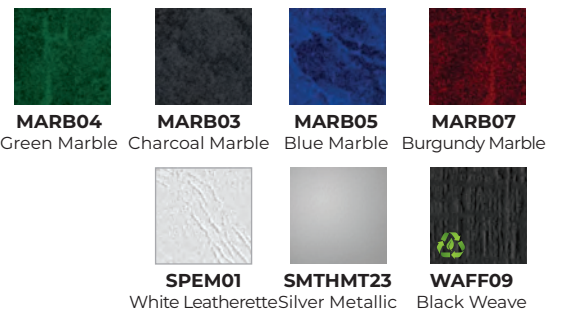

Award-winning promotional products supplier

# Presentation Folders | Jotters, Journals & Scratch Pads

## Custom Printed Jotters & Journals

**Stock:** Smooth white cardstock

**Pad:** 30 perforated sheets. See pad options below.

**Imprint:** 4-color process on front cover, back cover, and header.

**Weight:** 10 lbs. per 100 (FP35)  
22 lbs. per 100 (FP57)



FP35: 3" x 5"

### Jotters & Journals 100 250 500 1000 1500

FP35 3" x 5" Jotter 2.56 2.18 1.83 1.67 1.45

FP57 5" x 7-3/4" Journal 3.29 2.87 2.56 2.35 2.11

5C. No less than minimum available. Inside cover printing available for \$0.40 (C) each.



**Ruled Paper** Standard pad option  
**Plain Paper**  
**Grid Paper**  
**Watermark Logo** Ruled or plain paper  
**Custom Notepad**



SP811-25-1  
Shown with bleed. 8-1/2" x 11" pad also available with no bleed.

SP69-25-1

**NEW!**

## Scratch Pads

**Stock:** 50# White Opaque Text Stock with White Card Stock Backer

**Pad:** 25 or 50 pages

**Imprint:** 4-color process



Pad Size	Item #	Page Count	Min. 50 pads	Weight
3.8" x 7.8"	SP37-25-1	25	1.89	10 lbs. per 100
3.8" x 7.8"	SP37-50-1	50	3.69	17 lbs. per 100
4" x 6"	SP46-25-1	25	1.89	9 lbs. per 100
4" x 6"	SP46-50-1	50	3.69	15 lbs. per 100
5" x 8"	SP58-25-1	25	1.89	14 lbs. per 100
5" x 8"	SP58-50-1	50	3.69	26 lbs. per 100
6" x 9"	SP69-25-1	25	3.79	16 lbs. per 100
6" x 9"	SP69-50-1	50	7.38	30 lbs. per 100
8-1/2" x 11"	SP811-25-1NB	25	3.79	33 lbs. per 100
8-1/2" x 11"	SP811-50-1NB	50	7.53	31 lbs. per 50
8-1/2" x 11"	SP811-25-1	25	7.58	33 lbs. per 100
8-1/2" x 11"	SP811-50-1	50	14.76	31 lbs. per 50

1C. Second-side printing available.

**Card Holders**

- Perfect for hotel key cards, gift cards, or IDs
- Fits a standard-sized card



**Stock:** Smooth white cardstock

**Imprint:** 4-color process

**Weight:** 2 lbs. per 100



2001

**Card Holders**

		150	250	500	1000
<b>2002</b>	Pocket Card Holder	1.06	0.83	0.71	0.64
<b>2001</b>	Mini Card Folder	1.06	0.83	0.71	0.64
<b>2001-SLIT</b>	Slit Card Holder	1.06	0.83	0.71	0.64
<b>2002-H</b>	Horiz. Card Holder	1.15	0.91	0.79	0.69
<b>2002-S</b>	Sleeve Card Holder	1.06	0.83	0.71	0.64

4C

**Mini Card Folders**

- Pocket is open on two sides for quick card insertion and removal

**Size:** 2-3/4" x 4-1/2" (closed)

**Pocket:** 3" high



2002



2002-S



**Sleeve Card Holders**

- Notched top for easy card removal

**Size:** 2-1/2" x 3-1/2"

**Pocket Card Holders**

- Can be used vertically or horizontally

**Size:** 2-3/4" x 3-3/4" (closed)

**Pocket:** 2-1/4" high



2002-SLIT

**Slit Card Holders**

- Slits hold the card in place

**Size:** 3-1/4" x 4-1/8" (closed)



2002-H

**Horizontal Card Holders**

- Oversized for larger gift cards, licenses, or member cards

**Size:** 4-3/4" x 3-1/8" (closed)

**Pocket:** 1-3/4" high

# Presentation Folders | Document Pouches

937

## Custom Printed Document Pouches

**Stock:** Smooth white cardstock

**Imprint:** Unlimited ink coverage, one side

**Size:** 931: 6" x 10-1/2"

932: 4-3/4" x 10-1/2"

933: 6" x 9-3/4" with 3/4" side and bottom gussets

**Weight:** 8 lbs. per 100



933

932

Custom Pouches	150	250	500	1000	1500	2000	2500
931, 932, 933	3.04	2.78	2.55	2.42	2.38	2.28	2.26

7C. Business card slits available on flap for \$0.15 (C) each.

## Stock Document Pouches

- Made out of white leatherette paper
- Imprint is black
- Shipping weight is 8 lbs. per 100



### 931 – Stock Automobile Pouches

**Size:** 6" x 10-1/2"

**Imprint Area:** 4-1/2" x 3-1/2" (Red & Blue)  
9-3/4" x 2" (Light Blue)

931-AB  
Auto Blue



931-AR  
Auto Red



Back flap printing on automobile pouches

931-ALB  
Auto Light Blue

### 932 – Stock Industry Pouches

**Size:** 4-3/4" x 10-1/2"

**Imprint Area:** 3" x 3"

Stock Pouches	150	250	500	1000	1500	2000	2500
931, 932 Black Imprint	1.66	1.32	1.03	0.81	0.75	0.70	0.65
931, 932 Addt'l Color	0.46	0.31	0.26	0.22	0.20	0.17	0.14

7C. Business card slits available on flap for \$0.15 (C) each.



932-LD  
Legal Documents

932-IP  
Important Papers

932-RE  
Real Estate Papers

932-ID  
Insurance Documents





**NEW!**

**Printed #10 Envelopes**

- Three envelope options:
  - Plain White (BXEPS-PW)
  - Security Tinted (BXEPS-ST)
  - Window with Security Tint (BXEPS-WS)
- Full-color imprint (one location standard)
- Gummed closure



ENVELOPES & SHIPPING BOX  
MADE WITH FSC MATERIAL

**Size:** 9-1/2" x 4-1/8" (#10 envelope)

**Imprint:** 4-color process on front or back

**Weight:** 7-1/2 lbs. per box of 500 envelopes

**Prices per box of 500 envelopes**

	1	2	3	4	5	6	7
<b>BXEPS-PW</b>	234.00	169.00	152.00	143.00	136.00	131.00	128.00
<b>BXEPS-ST</b>	237.00	172.00	155.00	145.00	138.00	133.00	131.00
<b>BXEPS-WS</b>	241.00	176.00	160.00	150.00	143.00	138.00	136.00

7A

**NEW!**

**Custom Printed Document Sleeves**

- Full-color on front and back
- Notched top for easy document removal
- Available in two standard sizes



**Stock:** Smooth white cardstock

**Imprint:** Unlimited ink coverage, one side

**Size:** 934: 4-1/2" x 9"

935: 6" x 9-1/4"

**Weight:** 934: 4 lbs. per 100

935: 5 lbs. per 100

Doc. Sleeves	150	250	500	1000	2000
<b>934</b>	2.35	1.81	1.39	1.19	1.05
<b>935</b>	2.35	1.81	1.39	1.19	1.05

5C



934



935



**Products shown:**  
 Corrugated Box (p. 25)  
 Tuck & Pillow Boxes (p. 26-27)

## Packaging, Signs & Hangers

Corrugated Boxes .....	25	Standeers .....	30
Pillow Boxes .....	26	Display Towers .....	31
Tuck Boxes & Themed Packaging .....	27	Door Hangers .....	32
Pen/Pencil Caddy .....	28	Bottle Hangers .....	33
Yard Signs .....	29		

**NEW!**

**Corrugated Boxes**

- Printed in full color on 200# white corrugated E-flute board
- 16 standard sizes (custom available)
- Single-side printing standard (second-side printing available)



**Imprint:** 4-color process

**Stock:** White corrugated E-flute board



DB531

DB753



DB662 shown with second-side printing

Finished Box Size	Item #	25	50	100	250	500	1000	2500	Weight
4-1/2" x 4-3/4" x 1-1/4"	SB441	-	-	1.06	0.96	0.86	0.80	0.73	12 lbs. per 100
5" x 3" x 1-1/2"	DB531	-	-	1.06	0.96	0.86	0.80	0.73	12 lbs. per 100
6" x 4" x 3"	DB643	2.94	2.78	2.55	2.31	2.07	1.91	1.75	8 lbs. per 25
6" x 5" x 2-3/4"	DB652	2.94	2.78	2.55	2.31	2.07	1.91	1.75	3.75 lbs. per 25
6" x 6" x 2"	DB662	-	2.32	2.12	1.92	1.72	1.59	1.46	9 lbs. per 50
7" x 5" x 3"	DB753	3.68	3.48	3.18	2.88	2.59	2.39	2.19	6.25 lbs. per 25
8" x 5" x 3"	DB853	3.68	3.48	3.18	2.88	2.59	2.39	2.19	10 lbs. per 25
8" x 6" x 3"	DB863	3.68	3.48	3.18	2.88	2.59	2.39	2.19	10 lbs. per 25
8" x 8" x 5"	DB885	5.73	5.41	4.93	4.46	3.98	3.66	3.18	15 lbs. per 25
9" x 6" x 4"	DB964	5.73	5.41	4.93	4.46	3.98	3.66	3.18	10.75 lbs. per 25
9" x 8" x 2"	DB982	3.68	3.48	3.18	2.88	2.59	2.39	2.19	8.25 lbs. per 25
9-1/2" x 7-3/4" x 4"	DB974	7.16	6.76	6.17	5.57	4.97	4.57	3.98	13.25 lbs. per 25
10" x 8" x 4"	DB1084	7.16	6.76	6.17	5.57	4.97	4.57	3.98	15 lbs. per 25
12" x 9" x 2"	DB1292	4.91	4.64	4.24	3.85	3.45	3.18	2.92	10.75 lbs. per 25
12" x 10" x 4"	DB12104	9.55	9.02	8.22	7.43	6.63	6.10	5.30	14 lbs. per 25
16" x 16" x 2-3/4"	DB16162	14.32	13.53	12.33	11.14	9.95	9.15	7.96	21 lbs. per 25

7C. Single-side prices shown. Second-side printing available.

Box sizes above are measured Width x Depth x Height.

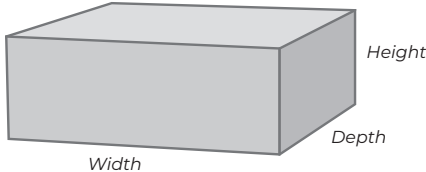

# Packaging | Pillow Boxes

2000-L

## Pillow Boxes

- Assembles quick! Just pop into shape and fold in the flaps.
- We make the box, you fill it with goodies
- Perfect for in-store packaging or event giveaways



**Imprint:** 4-color process

**Stock:** Smooth white cardstock

2000-M

2000-P

Pillow Boxes	250	500	1000	2500
<b>2000-P</b> Pen Box	1.44	1.11	0.96	0.85
<b>2000-S</b> Small	1.53	1.17	1.02	0.89
<b>2000-M</b> Medium	1.81	1.39	1.19	1.04
<b>2000-L</b> Large	1.93	1.47	1.31	1.16
<b>2000-J</b> Jumbo	2.33	1.79	1.56	1.41
<b>2000-XL</b> Xtra Large	2.44	1.87	1.63	1.47

4C



**SCAN FOR PRICING**



2000-XL



### 2000-P (Pen)

6-3/8" w x 2-1/4" h x 3/4" d

- Holds 2-5 pens
- Pair it with a jotter (p. 20)
- Fits small jewelry

**WEIGHT:** 3 lbs. per 100



### 2000-S (Small)

3-3/4" w x 2-1/2" h x 1-3/8" d

- Gift card-sized
- Fits mini gifts
- Point-of-purchase box

**WEIGHT:** 3 lbs. per 100



### 2000-M (Medium)

6" w x 4-1/2" h x 1-1/2" d

- Holds small giveaways
- Perfect sample size box
- Ideal for trade shows

**WEIGHT:** 5 lbs. per 100



### 2000-L (Large)

6" w x 6" h x 2" d

- Make your own gift box
- Ideal subscription box size
- Great for retail packaging

**WEIGHT:** 6 lbs. per 100



### 2000-J (Jumbo)

9-1/4" w x 5-5/8" h x 2-1/2" d

- Oversized gift box
- Fits a rolled-up t-shirt
- Perfect for kits

**WEIGHT:** 7 lbs. per 100



### 2000-XL (Xtra Large)

10-1/2" w x 6-1/2" h x 3" d

- Holds a long-sleeved shirt or two t-shirts
- Great for larger kits
- Unique gift box

**WEIGHT:** 10 lbs. per 100

2005-L



2005-SQ  
(with snap-bottom closure)



2005-M

2005-P  
(Pens not included)



**Tuck Boxes**

- Sturdy tuck-flap boxes printed in full color
- We make the box, you fill it with goodies
- Perfect for in-store packaging or event giveaways



**Imprint:** 4-color process

**Stock:** Smooth white cardstock

Item #	Size	150	250	500	1000	2500	Weight
<b>2005-P (Pen)</b>	1-3/4" w x 6" h x 3/4" d	-	1.44	1.11	0.96	0.85	3 lbs. per 100
<b>2005-M (Medium)</b>	3" w x 4" h x 1-1/2" d	-	1.81	1.39	1.19	1.04	3 lbs. per 100
<b>2005-L (Large)</b>	3-3/4" w x 5-3/4" h x 2-1/4" d	-	1.93	1.47	1.31	1.16	5 lbs. per 100
<b>NEW! 2005-XL (X-Large)</b>	4-1/2" w x 12" h x 2-1/2" d	-	2.44	1.87	1.63	1.47	9 lbs. per 100
<b>2005-SQ (Square)</b>	5" w x 2" h x 5" d	-	1.81	1.39	1.19	1.04	7 lbs. per 100
<b>2005-G (Golf Sleeve)</b>	1-1/2" w x 5-1/8" h x 1-1/2" d	2.34	1.81	1.39	1.19	1.05	4 lbs. per 100

2005-G is 5C. All others are 4C.

**Themed Gift Boxes**

- Say thank you, celebrate a special occasion, or give holiday gifts with themed packaging.
- Perfect for using as: Gift Packaging, Mini Kits, Gift Box Alternative, Treat Box, or Retail Packaging.



**Size:** Available in all styles and sizes on p. 26 & 27. Prices of themed boxes are the same as custom.

**Imprint:** 4-color process

**Stock:** Smooth white cardstock

**Available Themes:** Congratulations, Celebrate, Thank You, Welcome, Birthday, and Holiday

**Natural Thanks**  
Large Tuck Box  
2005-LT



**Pine Holiday Greetings**  
Large Pillow Box  
2000-LT



**Balloon Celebration**  
Medium Tuck Box  
2005-MT



**Ribbon Congratulations**  
Small Pillow Box  
2000-ST

Browse the entire line at [WarwickPublishing.com](http://WarwickPublishing.com)

**NEW!**

**Pen/Pencil Caddy**

- Organize pens or pencils at the reception or check-in desk
- Six pen slots. Pens not included.
- Ships flat; easily pops into shape.
- Free mailing envelopes available upon request (not inserted)



**Imprint:** 4-color process  
**Stock:** Smooth white cardstock  
**Size:** 4" w x 4-7/8" h x 3-1/4" d  
**Weight:** 5 lbs. per 100



Pen/Pencil Caddy	250	500	1000	2500
892	2.93	2.25	1.92	1.68

4C

**Not just for pens & pencils!**

- Toothbrushes
- Candy canes & suckers
- Tire pressure gauge
- WD-40 Precision Pen
- Small, lightweight tools



# NEW!



**YRD-1218-DS**  
12" x 18"



**YRD-2418-DS**  
24" x 18"



**YRD-1824-DS**  
18" x 24"



**YRD-1812-DS**  
18" x 12"

## Yard Signs

- Printed in full color on both sides
- Two standard sizes
- Horizontal or Vertical
- Custom sizes & shapes available
- Metal H-stake available (sold separately)



**Size:** 18" x 24" or 12" x 18"

**Imprint:** 4-color process, both sides

**Stock:** 4mm corrugated plastic (Coroplast)

**Weight:** 18" x 24": 12 lbs. per 10  
12" x 18": 5 lbs. per 10

## H-Stake Stand

**Size:** 10" x 30"

**Stock:** Metal

**Weight:** 22 lbs. per 10

**STK-1030** 10-piece min. 1.48 (C)

Yard Signs		10	50	100	250	500	1000	2500
<b>YRD-2418-DS</b>	24" x 18"	10.85	8.44	6.63	6.14	5.26	4.66	4.43
<b>YRD-1812-DS</b>	18" x 12"	5.43	4.22	3.33	3.09	2.63	2.35	2.23
<b>YRD-1824-DSV</b>	18" x 24"	13.57	10.55	8.28	7.70	6.59	5.82	5.54
<b>YRD-1218-DSV</b>	12" x 18"	6.78	5.27	4.14	3.85	3.28	2.92	2.76

7C



**STK-1030**

Shown with 24" x 18" sign

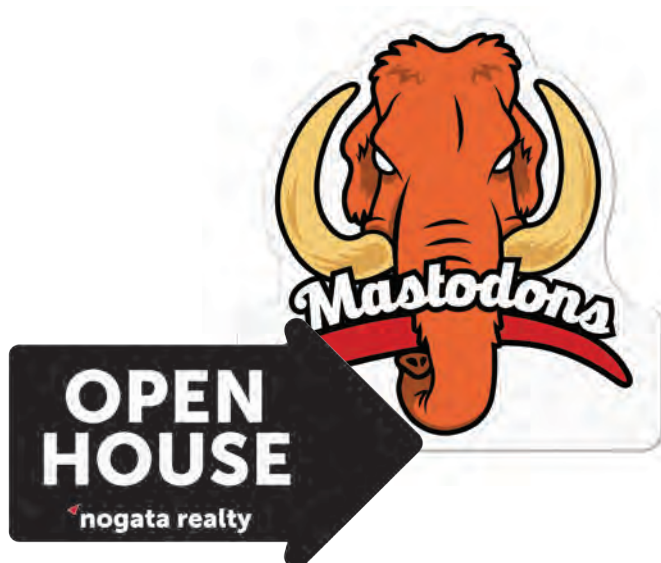

## Custom Yard Sign Shapes & Sizes

Take your branding further. We can cut custom-shaped yard signs or create custom sizes to suit your branding needs.

If using an H-stake, please keep in mind that the stakes are 10" apart and extend 8" into the sign. Max size for custom is 47-1/2" x 95-1/2"

**NEW!**

**Standeess**

- Printed in full color with full bleed
- Available with single- or double-sided printing
- Two notches for easy, sturdy assembly
- Available in 8-½" x 11" or 11" x 17"



**Imprint:** 4-color process

**Stock:** 4mm corrugated plastic (Coroplast)



STE811-2

**8-½" x 11" Standee**

**Size:** 8-½" x 11" / Base: 8-½" x 2-7/8"

**Weight:** 12 lbs. per 30

8-½" x 11" Standee	30	90	150	300	500	1000
STE811-1 Printed 1 Side	3.64	3.23	2.91	2.63	2.39	2.18
STE811-2 Printed 2 Sides	4.58	4.07	3.66	3.30	3.00	2.74

6A



STE1117-1

**11" x 17" Standee**

**Size:** 11" x 17" / Base: 11" x 3-7/8"

**Weight:** 12 lbs. per 16

11" x 17" Standee	16	48	80	150	250	500
STE1117-1 Printed 1 Side	5.20	4.62	4.16	3.75	3.41	3.12
STE1117-2 Printed 2 Sides	6.55	5.81	5.23	4.72	4.29	3.93

6A

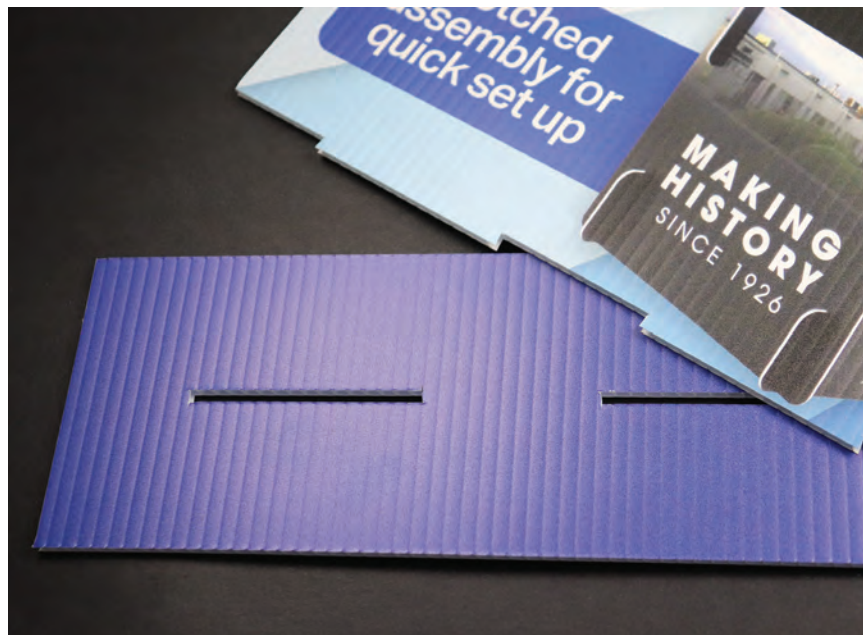

Notched tabs for easy assembly and sturdy construction.

**NEW!**

**Display Tower**

- Printed in full color on sturdy corrugated plastic
- Available printed one side or two
  - Printed 1 Side – TOW4P18-1
  - Printed 2 Sides – TOW4P18-2
- Notched pieces for quick and easy assembly
- Disassembles to eight 18" x 18" and four 5" x 18" panels for ease of shipping and transporting



**Assembled Size:** 57" x 18"

**Main Panel Sizes:** 18" x 18"

**Top & Bottom Panel Sizes:** 5" x 18"

**Imprint:** 4-color process

**Stock:** 4mm corrugated plastic (Coroplast)

**Weight:** 8 lbs. per 1

Display Tower	1	2	5	10	25	50
TOW4P18-1	70.72	68.40	66.56	60.09	54.54	49.92
TOW4P18-2	89.01	86.10	83.77	75.62	68.65	62.82

6A

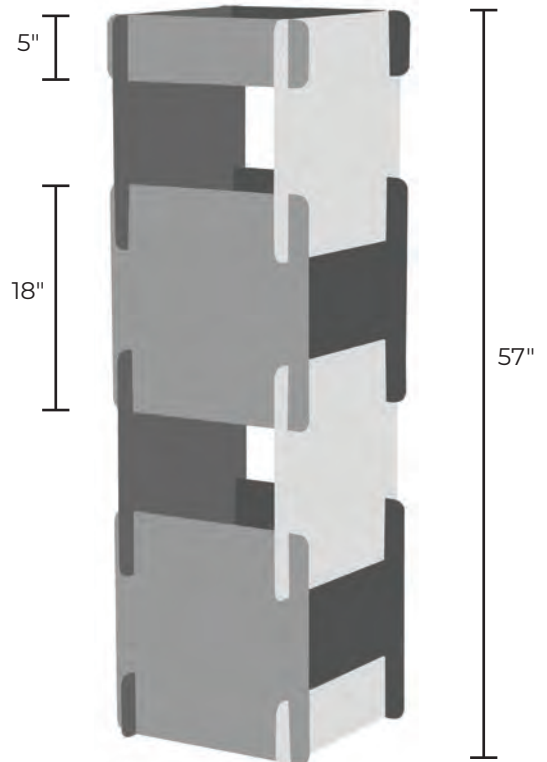

TOW4P18-2

# Hangers | Door Hangers

## Door Hangers

- Great for service professionals and the hotel industry
- Print both sides! Add your business info and company branding on front and back
- Pre-punched die-cut hole fits any standard door knob



**Imprint:** 4-color process

**Stock:** Smooth white cardstock

**Weight:** 2010: 1 lb. per 100  
All others: 2 lbs. per 100

Door Hangers	250	500	1000	2500
2004 8-1/2" x 3-1/2"	0.85	0.65	0.57	0.50
2009 13" x 4"	1.25	0.98	0.84	0.73
2010 7" x 4"	1.06	0.81	0.70	0.63
2011 10-1/2" x 4"	1.06	0.81	0.70	0.63
2012 11" x 6-1/2"	1.57	1.21	1.05	0.92

4C



2004 | 8-1/2" x 3-1/2"



2009 | 13" x 4"



2011 | 10-1/2" x 4" **NEW!**



2010 | 7" x 4" **NEW!**



2012 | 11" x 6-1/2" **NEW!**



## Pocket Door Hangers

- Large-sized custom door hanger
- Pocket holds brochures or small giveaways
- Print everywhere! Add your business info and company branding on the front, back, and pocket.
- Pre-punched die-cut hole fits any standard door knob



**Imprint:** 4-color process

**Stock:** Smooth white cardstock

**Weight:** 4 lbs. per 100

## Pocket Door Hangers

Pocket Door Hangers	250	500	1000	2500
2003 Printed Both Sides	2.55	1.96	1.67	1.46

4C



**2008-T**  
Tall Bottle Necker



**2008-S (Short Necker)**  
1-½"h x 1-⅘"w (Top width)  
1-⅑" w (Bottom width)



**2008-T (Tall Necker)**  
2-⅜"h x 1-⅜" w (Top width)  
1-⅑" w (Bottom width)

**Bottle Neckers**

- Promote breweries, distilleries, drink recipes, events, or special occasions.
- Print on 4 outside panels AND 4 inside panels, giving you 8 sides of printing for brand info
- Easy to assemble with folding tab closure



**Imprint:** 4-color process  
**Stock:** Smooth white cardstock  
**Weight:** 2 lbs. per 100

Bottle Neckers	250	500	1000	2500
<b>2008-S</b> Short	1.06	0.83	0.69	0.61
<b>2008-T</b> Tall	1.06	0.83	0.69	0.61

4C

**Bottle Hangers**

- Say thank you, celebrate a special occasion or event, or promote a product, service, or brand.
- Styles to fit a variety of bottle sizes
- Print both sides! Add your business info and company branding on the front and back.
- Pre-punched die-cut holes



**Imprint:** 4-color process  
**Stock:** Smooth white cardstock  
**Weight:** 4 lbs. per 100

Bottle Hangers	250	500	1000	2500
<b>2006-C</b> Circle	0.64	0.48	0.42	0.38
<b>2006-S</b> Small	0.64	0.48	0.42	0.38
<b>2006-B</b> Brochure	0.85	0.65	0.57	0.50
<b>2006-L</b> Large	0.85	0.65	0.57	0.50
<b>2004-C</b> Tall	0.85	0.65	0.57	0.50

4C



**2006-C (Circle)**  
3-½" diameter

- 1-½" opening
- Perfect for event promotions

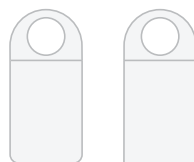

**2006-S (Small)**  
2-½" w x 5-⅙" h

- Creased, rounded top with 1.3" opening
- Rounded or Straight edges

2006-S  
Straight Edges

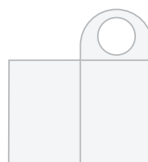

**2006-B (Brochure)**  
2-½" w x 5-⅙" h

- Creased, rounded top with 1.3" opening
- Folded piece for extra info or imagery

2006-LR  
Rounded Edges



**2006-L (Large)**  
3-⅝" w x 7" h

- Creased, rounded top with star-cut opening fits most bottles
- Round or Square edges

2006-LS  
Straight Edges

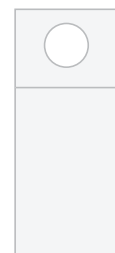

**2004-C (Tall)**  
3-½" w x 8-½" h

- Creased, squared-off top with 1.5" opening
- Large bottle hanger for extra ad space



**Products shown, from left:**  
**F6637-MINI** Fuji Instax Mini Frame  
**DF5810-46** 4" x 6" Printed Dual Easel Frame  
**F6637-INSTAX** Fuji Instax Frame  
*(all shown on p. 41)*

## Photo Frames & Folders

Golf-Themed Frames & Folders .....	35
Portrait Folders.....	36
Photo Folders .....	37
Full-Color Photo Folders.....	38
Coupon Gatefold Photo Folders.....	39
Double-Sided Frames & Folders.....	40

Full-Color Paper Frames.....	41
Foil Stamped Paper Frames.....	42
Cardboard Photo Frames .....	43
Bevel Photo Frames & Mat Boards .....	44-45
Certificate Frames & Folders .....	46-49

# Frames & Folders | Golf-Themed Frames & Folders



## Golf Ball Textured Mat Board Frame

- Our popular golf ball textured paper
- Heavy-duty mat board frame backing
- Easel back for horizontal or vertical display
- Available with or without dark green mat



**Size:** 8" x 10"

**Opening:** 6-3/4" x 4-3/4" (holds a 5" x 7" photo)

**Imprint Color:** Gold foil

454-30

454-3044

### 454-30 Single Mat

**Horizontal Imprint:** 7-1/2" x 3/4"

**Vertical Imprint:** 5-1/2" x 3/4"

**Weight:** 24 lbs. per 100

### 454D-3044 Double Mat

**Horizontal Imprint:** 7-1/4" x 1/2"

**Vertical Imprint:** 5-1/4" x 1/2"

**Weight:** 29 lbs. per 100

Golf Ball Texture Frame	50	100	150	250	500	1000
454-30 Single Mat	7.94	7.72	6.93	5.82	5.79	5.06
454D-3044 Double Mat	11.77	11.40	10.63	9.03	8.45	7.43



PF5850V-46

PF5850H-57

6C

## Golf Gatefold Photo Folders

**4" x 6" Opening:** 3-5/8" x 5-5/8"

**5" x 7" Opening:** 4-1/2" x 6-1/2"

**Imprint Color:** Gold or Silver foil

**Weight:** 6 lbs. per 100



### Vertical

**Imprint:** 2-1/2" x 7"

**Size (folded):** 6-1/16" x 8-3/16"

PF5850V-46: 4" x 6" folder

PF5850V-57: 5" x 7" folder

### Horizontal

**Imprint:** 3" x 5"

**Size (folded):** 8-3/16" x 6-1/8"

PF5850H-46: 4" x 6" folder

PF5850H-57: 5" x 7" folder



735

764

## Golf Ball Textured Photo Folders

- **735:** Single Horizontal Opening
- **737:** Double Horizontal Opening
- **764:** Double Opening (Horizontal & Vertical)



**Opening:** 5-1/2" x 3-1/2" (holds a 4" x 6" photo)

**Imprint Color:** Gold foil

### 735 & 737

**Imprint:** 5" x 3-1/2"

**Size (folded):** 7-5/8" x 5-1/2"

**Weight:** 5 lbs. per 100

### 764

**Imprint:** 5-1/8" x 3-1/8"

**Size (folded):** 7-3/4" x 7-3/4"

**Weight:** 8 lbs. per 100

PF5850 Imprinted	50	100	150	250	500	1000
4" x 6" & 5" x 7"	4.27	3.78	3.55	3.24	3.00	2.90

6A. Envelopes not included.

PF5850 Unimprinted	50-999	1000+
4" x 6" & 5" x 7"	2.54	2.44

2A. Envelopes not included.

Award-winning promotional products supplier

	50	75	100	150	250	500	1000
<b>735</b>	6.38	5.17	4.32	3.69	3.34	3.10	2.90
<b>737</b>	6.50	5.34	4.79	4.07	3.68	3.47	3.16
<b>764</b>	7.96	6.71	6.10	5.51	5.15	4.81	4.46

7C. Envelopes not included. Ships flat, not folded.

Warwick Publishing

**Portrait Folders**

- Crafted out of 20 pt. black or white weave, recycled paper stock
- Deckle edge detailing
- Add your logo in gold or silver foil



4" x 6" Horizontal

5" x 7" Horizontal

4" x 6" Vertical

Portrait Folders	150	250	500	1000	1750	2500
4" x 6"	2.81	2.25	1.72	1.63	1.41	1.20
5" x 7"	3.04	2.52	1.84	1.70	1.50	1.31

4A, B, C. Envelopes not included. Ships flat, not folded. If border is requested, add \$0.35 (C) each.

	50	75	100	500	1000
8" x 10"	6.03	4.75	3.91	3.52	3.34
8-1/2" x 11"	6.03	4.75	3.91	3.52	3.34

5A. Envelopes not included. Ships flat, not folded. Border not available.

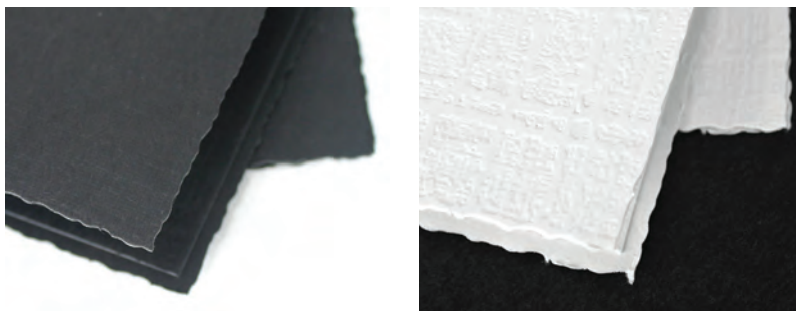

Weave texture and deckle edge details

4" x 6" and 5" x 7" available with gold or black foil window borders (charges apply).



Portrait Folder Specs	Item # (Black)	Item # (White)	Imprint	Folded	Opening	Weight per 100
4" x 6" Horizontal	PFH5509-46	PFH5501-46	4" x 6"	8-3/16" x 6-1/8"	3-5/8" x 5-5/8"	10 lbs.
4" x 6" Vertical	PFV5509-46	PFV5501-46	4" x 6"	6-1/16" x 8-1/8"	3-5/8" x 5-5/8"	10 lbs.
5" x 7" Horizontal	PFH5509-57	PFH5501-57	5" x 7"	9" x 7-1/16"	4-1/2" x 6-1/2"	13 lbs.
5" x 7" Vertical	PFV5509-57	PFV5501-57	5" x 7"	6-7/8" x 9"	4-1/2" x 6-1/2"	13 lbs.
8" x 10" Horizontal	PFH5509-810	PFH5501-810	6" x 8"	11-9/16" x 9-5/8"	7-1/2" x 9-1/2"	24 lbs.
8" x 10" Vertical	PFV5509-810	PFV5501-810	6" x 8"	9-5/8" x 11-9/16"	7-1/2" x 9-1/2"	24 lbs.
8-1/2" x 11" Horizontal	PFH5509-811	PFH5501-811	6" x 8"	13-1/4" x 10-7/8"	8" x 10-1/2"	24 lbs.
8-1/2" x 11" Vertical	PFV5509-811	PFV5501-811	6" x 8"	10-3/4" x 13-1/4"	8" x 10-1/2"	24 lbs.

Gold and silver foil standard. See imprint location options on page 37.

PFV745-810



**745 White Photo Folders**

**Stock:** 16 pt. white smooth coated paper  
**Foil Imprint:** Gold or Silver foil



745	100	150	250	500	1000	2500
4" x 6"	3.33	2.56	2.05	1.67	1.44	1.35
5" x 7"	3.50	2.74	2.14	1.75	1.57	1.40
8" x 10"	4.09	3.39	2.84	2.55	2.35	2.14

6C. Envelopes not included. Ships flat, not folded.

PFH745-46

PFH745-57

PFV731-810



**731 Black Photo Folders**

**Stock:** 20 pt. black weave recycled paper board  
**Foil Imprint:** Gold or Silver foil



731	100	150	250	500	1000	2500
4" x 6"	3.33	2.56	2.05	1.67	1.44	1.35
5" x 7"	3.50	2.74	2.14	1.75	1.57	1.40
8" x 10"	4.09	3.39	2.84	2.55	2.35	2.14

6C. Envelopes not included. Ships flat, not folded.

PFH731-57

PFV731-46

745 & 731 Specs	Imprint Area	731 Opening	731 Folded	745 Opening	745 Folded	Orientation	Weight per 100
4" x 6"	3" x 5"	3-1/4" x 5-1/4"	4-1/2" x 6-1/4"	3-3/8" x 5-1/8"	4-1/2" x 6-1/4"	Horiz. or Vert.	5 lbs.
5" x 7"	4" x 6"	4-1/4" x 6-1/4"	5-1/2" x 7-1/2"	4-1/8" x 6-1/4"	5-3/8" x 7-3/4"	Horiz. or Vert.	6 lbs.
8" x 10" Vertical only	6" x 9"	7-1/4" x 9-1/4"	8-1/2" x 10-3/4"	6-3/4" x 9"	8-1/4" x 10-1/4"	Vertical	10 lbs.

Please specify Vertical or Horizontal folders when ordering.

**Photo Folder Imprint Locations**

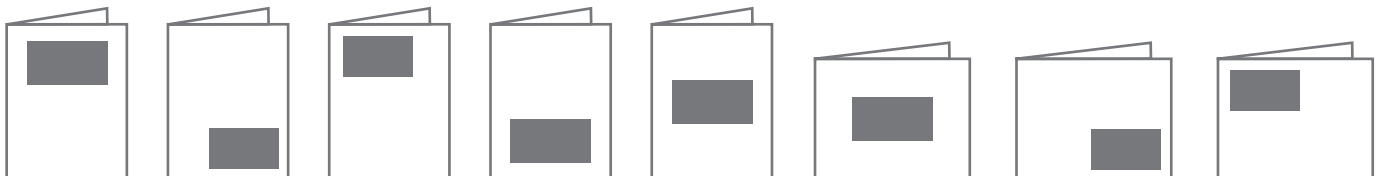

Vertical Top Half Centered

Vertical Bottom Right

Vertical Top Left

Vertical Bottom Half Centered

Vertical Centered

Horizontal Centered

Horizontal Bottom Right

Horizontal Top Left

# Frames & Folders | Full-Color Photo Folders

## Full-Color Photo Folders

- Build recognition with a custom, digitally printed photo event folder
- Available for 4" x 6" and 5" x 7" photos



PFVDLX



PFHSTD

Full-Color Folders		150	250	500	1000	1750	2500
<b>Standard</b> One Side		4.30	3.63	3.09	2.65	2.36	2.07
<b>Deluxe</b> Both Sides		6.08	5.18	4.58	4.01	3.52	3.16

6A. Envelopes not included. Available for \$0.20 (D). 6-3/8" x 8-3/16" (not 1st Class rate).

## Standard Photo Folders

Printed on the front cover, back cover, and window border. Vertical shown. Also available in horizontal.



PFVSTD – Vertical / Single Window  
PFHSTD – Horizontal / Single Window



PFVSTDDS – Vertical / Double Window  
PFHSTDDS – Horizontal / Double Window



PFVDLX – Vertical / Single Window  
PFHDLX – Horizontal / Single Window



PFVDLXDS – Vertical / Double Window  
PFHDLXDS – Horizontal / Double Window

## Deluxe Photo Folders

Printed on the front cover, back cover, window border, and inside panels. Vertical shown. Also available in horizontal.

## Photo Booth Photo Folders

- Holds one 2" x 6" photo booth strip
- Choose Pocket or Corner Slits style



**Size:** PF5820 (corner slits): 3" x 7" (closed)  
PF5820-PK (pocket): 2-3/4" x 6-3/4" (closed)  
**Imprint:** 4-color process  
**Stock:** Smooth white cardstock  
**Weight:** 3 lbs. per 100



PF5820



PF5820-PK

Photo Booth	100	150	250	500	1000
<b>Both Styles</b>	1.69	1.43	1.16	1.04	0.97

5A



PF5852H-46CPNS

**Full-Color Custom Photo Frames**

- Choose 4 or 8 coupons on folder flaps
- Available for 4" x 6" and 5" x 7" horizontal photos
- Standard and Deluxe options



**Size:** 8-3/16" x 6-1/8" (closed)  
16-9/16" x 6-1/8" (open)

**Imprint:** 4-color process. Available as Standard (one-sided printing) or Deluxe (two-sided printing)

**Stock:** Smooth white cardstock

**Weight:** 6 lbs. per 100

Full-Color Folders	150	250	500	1000	1750	2500
<b>Standard</b> One Side	4.30	3.63	3.09	2.65	2.36	2.07
<b>Deluxe</b> Both Sides	6.08	5.18	4.58	4.01	3.52	3.16

6A. Envelopes not included. Available for \$0.20 (D). 6-1/8" x 8-3/16" (not 1st Class rate).

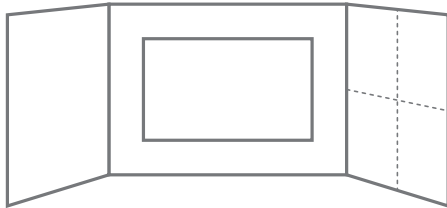

**4 coupons**

- PF5852H-46CPNS 4x6, Standard
- PF5852H-57CPNS 5x7, Standard
- PF5852H-46CPND 4x6, Deluxe
- PF5852H-57CPND 5x7, Deluxe



Perfect for conventions! A practical giveaway for new and existing customers.

**Shown:** PF5852H-57CPNS



Add sponsor promotions to the coupons—great for different sponsorship levels.

**Shown:** PF5852H-46PND (Deluxe Folder shown)

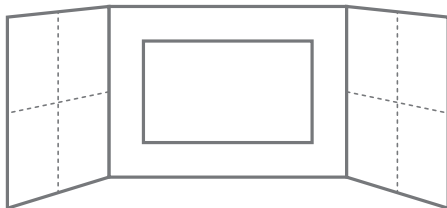

**8 coupons**

- PF5852H-46CPNS8 4x6, Standard
- PF5852H-57CPNS8 5x7, Standard
- PF5852H-46CPND8 4x6, Deluxe
- PF5852H-57CPND8 5x7, Deluxe



Wineries and Breweries can include offers and discounts.

**Shown:** PF5852H-57CPNS8



Event venues can include coupons for other amenities.

**Shown:** PF5852H-46PNS8

# Frames & Folders | Double-Sided Frames & Folders

## Double-Sided Portrait Folders

- Made out of 20 pt. black or white weave recycled paper stock
- Deckle edge detailing
- Add your custom imprint in gold or silver foil
- Great for before and after pictures
- Popular for sports! Insert an individual portrait and one team or group photo.



Portrait Folders	150	250	500	1000	1750	2500
4" x 6"	3.04	2.50	1.93	1.73	1.54	1.31
5" x 7"	3.24	2.66	2.05	1.85	1.62	1.42

4A, B, C. Envelopes not included.

DSP Specs	Item # (Black)	Item # (White)	Imprint	Folded Size	Opening	Weight per 100
4" x 6" Horizontal	DSPH46-09	DSPH46-01	3-3/8" x 5-3/8"	8-3/16" x 6-1/8"	3-5/8" x 5-5/8"	13 lbs.
4" x 6" Vertical	DSPV46-09	DSPV46-01	3-3/8" x 5-3/8"	6-1/16" x 8-1/16"	3-5/8" x 5-5/8"	13 lbs.
5" x 7" Horizontal	DSPH57-09	DSPH57-01	4-1/4" x 6-1/4"	9" x 7-1/16"	4-1/2" x 6-1/2"	15 lbs.
5" x 7" Vertical	DSPV57-09	DSPV57-01	4-1/4" x 6-1/4"	6-7/8" x 9"	4-1/2" x 6-1/2"	15 lbs.

All double-sided portrait folders are shipped flat, not folded. See page 37 for imprint locations.

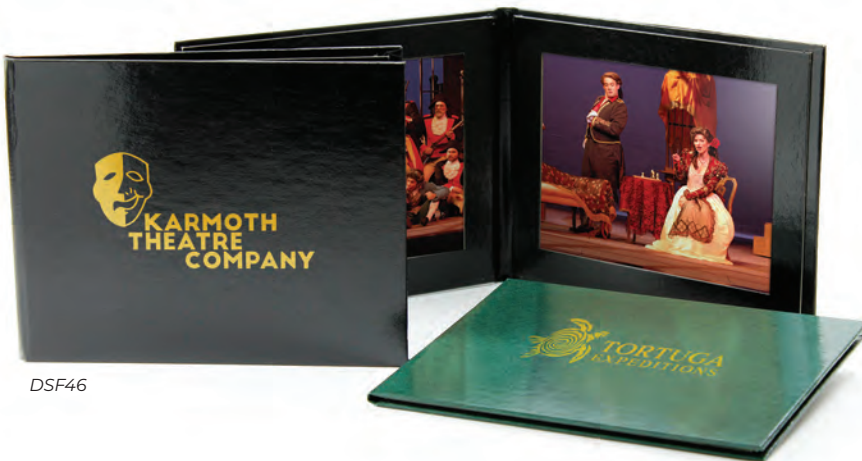

## Deluxe Wrapped Double-Sided Frame

- Holds two horizontal 4" x 6" photos
- Chipboard wrapped in green or black glossy paper
- Add your logo or custom imprint in gold foil



**Size (unfolded):** 13-1/4" x 5-1/4"

**Size (folded):** 6-9/16" x 5-1/4"

**Imprint:** 4-3/4" x 3-1/2"

**Imprint Color:** Gold foil

**Opening:** 4-15/16" x 3-3/4"

**Weight:** 14 lbs. per 100



Deluxe Frame	150	250	500	1000	1750	2500
DSF46	7.29	6.96	6.78	6.69	6.00	5.37

4A, B, C. Envelopes not included. Ships flat, not folded.



DF5810-57



DF5810-46

**Custom Printed Dual Easel Frames**

**Size:** 5-3/4" x 7-3/4" (4" x 6")  
7-1/2" x 9-3/8" (5" x 7")

**Imprint:** 4-color process on front and back

**Stock:** Smooth white cardstock

**Weight:** 4 lbs. per 100 (4" x 6")  
5 lbs. per 100 (5" x 7")



Dual Easel	150	250	500	1000	
4" x 6"	DF5810-46	2.37	2.28	1.92	1.67
5" x 7"	DF5810-57	4.37	3.68	3.14	2.71

4A. Envelopes not included. Ships flat, not folded.

**Fuji Instax & Polaroid Easel Frames**

**Imprint:** 4-color process on front and back

**Stock:** Smooth white cardstock

**Weight:** 5 lbs. per 100



**Frames**                      **Minimum 150**

<b>Instax &amp; Polaroid</b>	0.92
------------------------------	------

1A. Envelopes not included. Ships flat, not folded.



F6637-INSTAX



F6637-MINI

**Fuji Instax & Polaroid Frame Sizes**

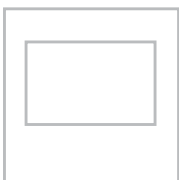

**Fuji Instax Frame**  
F6637-INSTAX – for Instax Wide

**Size:** 5" x 5" (folded)  
**Window Opening:** 3-3/4" x 2-3/8"

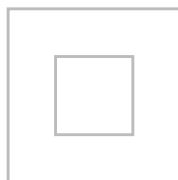

**Fuji Instax Square Frame**  
F6637-SQUARE

**Size:** 5" x 5" (folded)  
**Window Opening:** 2-1/4" x 2-1/4"

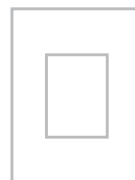

**Fuji Instax Mini Frame**  
F6637-MINI

**Size:** 3-3/4" x 5" (folded)  
**Window Opening:** 1-3/4" x 2-3/8"

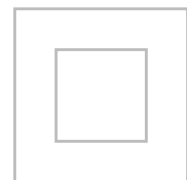

**Polaroid Frame**  
F6637-Polaroid

**Size:** 5" x 5" (folded)  
**Window Opening:** 2-5/8" x 2-5/8"  
(Polaroid 600, SX-70 & i-Type prints)

# Frames & Folders | Foil Stamped Paper Frames

## Dual Easel Frames

- Made out of 20 pt. black or white weave recycled paper stock
- Pop-out easels for horizontal or vertical display
- Add your custom imprint in gold or silver foil



### For 4" x 6" Photos

**Size:** 6" x 8"  
**Horizontal Imprint:** 7-1/2" x 1"  
**Vertical Imprint:** 5-1/2" x 1"  
**Opening:** 3-1/2" x 5-1/2"  
**Weight:** 10 lbs. per 100

PF5901-46: White 4" x 6"  
 PF5909-46: Black 4" x 6" (not shown)

### For 5" x 7" Photos

**Size:** 7" x 9"  
**Horizontal Imprint:** 8-1/2" x 1"  
**Vertical Imprint:** 6-1/2" x 1"  
**Opening:** 4-1/2" x 6-1/2"  
**Weight:** 12 lbs. per 100

PF5901-57: White 5" x 7" (not shown)  
 PF5909-57: Black 5" x 7"

PF5909-57



PF5901-46

Dual Easel	150	250	500	1000	1750	2500
4" x 6"	2.81	2.25	1.72	1.63	1.41	1.20
5" x 7"	3.04	2.52	1.84	1.70	1.50	1.31

4A, B, C. Envelopes not included.

## White Smooth Easel Frames

- Made out of sturdy, smooth 16 pt. white paper stock
- Pop-out easels for horizontal or vertical display
- Add your logo in gold or silver foil



### For 4" x 6" Photos

**Size:** 5-3/4" x 7-3/4"  
**Imprint:** 4" x 3/4"  
**Opening:** 3-1/2" x 5-1/2"  
**Weight:** 6 lbs. per 100

### For 5" x 7" Photos

**Size:** 7-1/2" x 9-3/8"  
**Imprint:** 5" x 7/8"  
**Opening:** 4-1/2" x 6-1/2"  
**Weight:** 8 lbs. per 100



EWH-46

EWH-57

EWH-810

EWH Photo Easels	50	100	150	250	500	1000	2500
4" x 6" EWH-46	4.58	3.20	2.50	2.01	1.61	1.30	1.16
5" x 7" EWH-57	4.95	3.45	2.67	2.13	1.71	1.61	1.44
4" x 6" EWH-810	6.08	4.25	3.32	2.59	2.05	1.96	1.77
Add'l Location	2.66	2.11	1.87	1.54	1.23	1.05	0.78

7C. Envelopes not included.

### For 8" x 10" Photos

**Size:** 10" x 11-15/16"  
**Imprint:** 8" x 1"  
**Opening:** 7-1/2" x 9-3/8"  
**Weight:** 14 lbs. per 100



**1357**  
White on White



**PF5815-57**  
Black on Black



**PF5809-46**  
White on Black



**PF5810-57**  
Black on White

**Cardboard Photo Frames**

- Your choice of black or white leatherette
- Made out of durable chipboard material
- For 4" x 6" or 5" x 7" photos



**For 4" x 6" Photos**

**Size:** 6-1/2" x 8-1/4"  
**Horizontal Imprint:** 7-1/2" x 3/4"  
**Vertical Imprint:** 5-1/2" x 3/4"  
**Opening:** 3-3/4" x 5-3/4"  
**Weight:** 17 lbs. per 100

**For 5" x 7" Photos**

**Size:** 7-1/4" x 9-1/4"  
**Horizontal Imprint:** 8-1/2" x 3/4"  
**Vertical Imprint:** 6-1/2" x 3/4"  
**Opening:** 4-3/4" x 6-3/4"  
**Weight:** 19 lbs. per 100

Photo Frames	150	250	500	1000	1750	2500
<b>4" x 6" or 5" x 7"</b>	4.68	4.37	4.15	3.90	3.48	3.13

4A, B, C. Envelopes not included. Price includes one color/location.  
 For additional color/location, see page 89.

Frame Info	4" x 6"	5" x 7"	Imprint Color(s)
<b>Standard</b>	1346	1357	Gold or Black
<b>White on Black</b>	PF5809-46	PF5809-57	Gold or Black
<b>Black on White</b>	PF5810-46	PF5810-57	Gold
<b>Black on Black</b>	PF5815-46	PF5815-57	Gold



Back of cardboard frames with easel for horizontal or vertical display.



**PF5809D-57**



**1300D-46**

**Full-Color Custom Photo Frames**

- Vibrant, full-color window frame
- Choose white or black backing
- For 4" x 6" or 5" x 7" photos



**Imprint:** 4-color process  
**Stock:** Smooth white cardstock on chipboard backing

Full-Color Frames	150	250	500	1000	1750	2500
<b>4" x 6" or 5" x 7"</b>	5.22	4.79	4.51	4.28	3.76	3.35

4A, B, C. Envelopes not included.

# Frames & Folders | Bevel Photo Frames

## Mat Board Bevel Frames

- Choose from 10 colors (see below)
- Beveled edge window adds a professional touch
- Gold foil imprint standard
- Easel back and hang tabs allow for horizontal or vertical display on the wall or desk



Imprinted	100	150	250	500	1000
<b>452</b> 4" x 6"	4.70	4.23	3.73	3.28	2.95
<b>454</b> 5" x 7"	5.10	4.63	4.10	3.56	3.26
<b>458</b> 8" x 10"	9.01	8.52	7.94	7.46	6.93

5C. Envelopes not included.



Blank	50-999	1000+
<b>452</b> 4" x 6"	2.61	2.10
<b>454</b> 5" x 7"	2.97	2.37
<b>458</b> 8" x 10"	6.52	5.66

2C

### 452 (for 4" x 6" photos)

**Size:** 7-3/4" x 5-3/4"  
**Horizontal Imprint:** 7-1/2" x 3/4"  
**Vertical Imprint:** 5-1/2" x 3/4"  
**Opening:** 5-3/8" x 3-3/8"  
**Weight:** 12 lbs. per 100

### 454 (for 5" x 7" photos)

**Size:** 10" x 8"  
**Horizontal Imprint:** 9-3/4" x 1-1/4"  
**Vertical Imprint:** 7-3/4" x 1-1/4"  
**Opening:** 6-3/8" x 4-3/8"  
**Weight:** 21 lbs. per 100

### 458 (for 8" x 10" photos)

**Size:** 13-1/4" x 10-3/4"  
**Horizontal Imprint:** 13" x 1-1/2"  
**Vertical Imprint:** 10-1/2" x 1-1/2"  
**Opening:** 9-3/8" x 7-3/8"  
**Weight:** 67 lbs. per 100

## Mat Colors

Cream trim standard unless otherwise noted.



## Mat Boards

- Pre-cut mat boards in 10 colors
- Bevel-cut opening for a stylish finish
- Ready to frame! Just add your imprint (gold foil standard).



Imprinted	100	150	250	500	1000
<b>MAT483</b>	9.47	8.90	8.43	7.83	7.39
<b>MAT484</b>	9.47	8.90	8.43	7.83	7.39
<b>MAT485</b>	9.47	8.90	8.43	7.83	7.39
<b>MAT486</b>	5.60	5.04	4.56	4.05	3.52
<b>MAT487</b>	5.60	5.04	4.56	4.05	3.52

5C

Blank	50-999	1000+
<b>MAT483</b>	6.49	5.61
<b>MAT484</b>	6.49	5.61
<b>MAT485</b>	6.49	5.61
<b>MAT486</b>	2.97	2.36
<b>MAT487</b>	2.97	2.36

2C

Mat Specs	Outer Size	Insert Size	Window Size	Horz. Imprint	Vert. Imprint	Weight per 100
<b>MAT483</b>	11" x 14"	8-1/2" x 11"	8-1/8" x 10-5/8"	13-1/4" x 0.95"	10-1/8" x 1.1"	25 lbs.
<b>MAT484</b>	11" x 14"	8" x 10"	7-1/2" x 9-5/8"	13-1/8" x 1.05"	10-1/8" x 1-1/2"	25 lbs.
<b>MAT485</b>	11" x 14"	5" x 7"	4-5/8" x 6-5/8"	13" x 2-1/2"	10" x 3"	35 lbs.
<b>MAT486</b>	8" x 10"	5" x 7"	4-3/8" x 6-3/8"	8-7/8" x 1-1/4"	7-1/5" x 1-1/5"	11 lbs.
<b>MAT487</b>	8" x 10"	4" x 6"	3-5/8" x 5-5/8"	8-7/8" x 1-1/2"	7" x 1-1/2"	11 lbs.

**NEW!**

**Printed Bevel Frames & Mat Boards**

- Full-color printed mat boards
- Printed on White for vibrant colors
- Available in all frame and mat board sizes listed on page 44



**Imprint:** 4-color process

**Stock:** White Mat Board

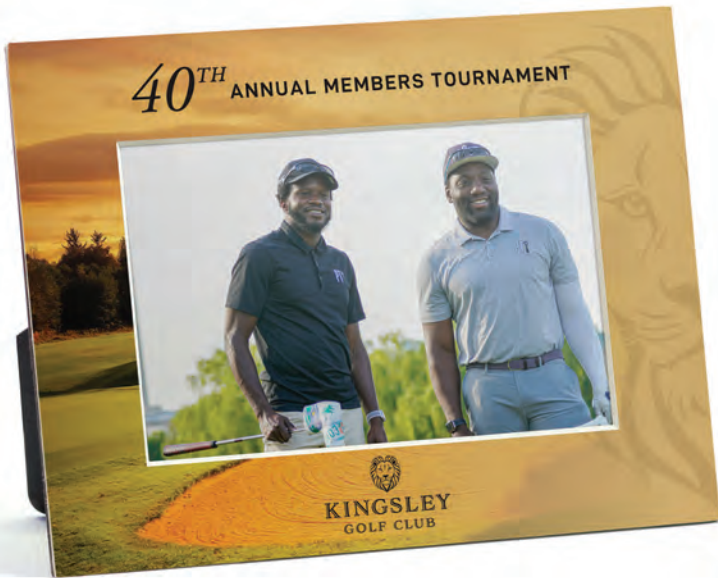

452-DP

Bevel Frames	50	100	250	500	1000
<b>452-DP</b> 4" x 6"	5.66	5.14	4.65	4.11	3.62
<b>454-DP</b> 5" x 7"	6.63	6.04	5.71	5.51	4.76
<b>458-DP</b> 8" x 10"	11.30	10.27	9.46	8.81	8.27

5C. Envelopes not included.

Mat Boards	50	100	150	250	500
<b>MAT483-DP</b>	12.07	11.35	10.74	9.99	9.42
<b>MAT484-DP</b>	12.07	11.35	10.74	9.99	9.42
<b>MAT485-DP</b>	12.07	11.35	10.74	9.99	9.42
<b>MAT486-DP</b>	7.14	6.42	5.81	5.16	4.49
<b>MAT487-DP</b>	7.14	6.42	5.81	5.16	4.49

5C



MAT484-DP



MAT487-DP

**Customize your event.**

Make your event even more memorable with a custom-cut photo mat. Multiple cut-outs, custom shapes, printed or foil stamped imprints, and more.

If you can dream it, we can make it.

**Please contact us for a quote.**

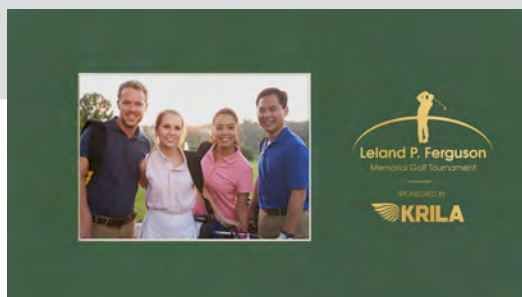
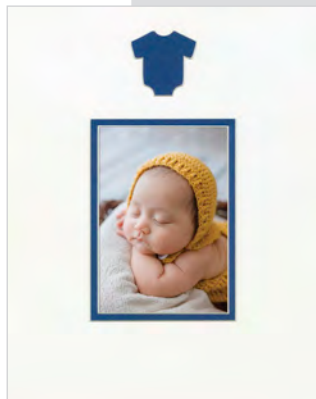

**Classic Certificate Folder**

- Dual corner slits accommodate 8" x 10" or 8-1/2" x 11" certificates
- Horizontal or vertical imprint



**Size:** 11-3/4" x 9-1/4"

**Imprint:** 4" x 5" or up to 20 square inches

**Imprint Color:** Gold

**Stock:** Burgundy, Black, Blue, Ivory, White, Gray, or Green Linen paper

**Weight:** 9 lbs. per 100

**Gold Corners:** Gold Corners are standard. If corners are not desired, purchase order must state, "No Corner Design"



589PT

589PT	50	100	250	500	1000	2500
<b>Imprinted</b>	6.13	5.00	4.19	3.75	3.03	2.44

6A. Envelopes not included. Ships flat, not folded.

589PT	50-999	1000+
<b>Blank</b>	3.47	2.02

2A. Envelopes not included. Ships flat, not folded.

**Full-Color Certificate Folder**

- Dual corner slits accommodate 8" x 10" or 8-1/2" x 11" certificates
- Horizontal or vertical imprint



**Size:** 11-3/4" x 9-1/4"

**Imprint Color:** 4-color process

**Stock:** Smooth white cardstock

**Weight:** 9 lbs. per 100



589-DP

589-DP	50	100	250	500	1000	2500
<b>Full Color</b>	6.23	5.00	4.15	3.70	2.95	2.32

6A. Envelopes not included. Ships flat, not folded.

**Premier Frame**

- Accommodates an 8-1/2" x 11" certificate
- Easel back and hanging tabs for horizontal or vertical display
- White ribbon corners and clear acetate protector keeps certificate snug and free of fingerprints

**Size:** 9" x 11-1/2"

**Imprint:** Not available

**Stock:** Black wrapped chipboard

**Weight:** 52 lbs. per 100

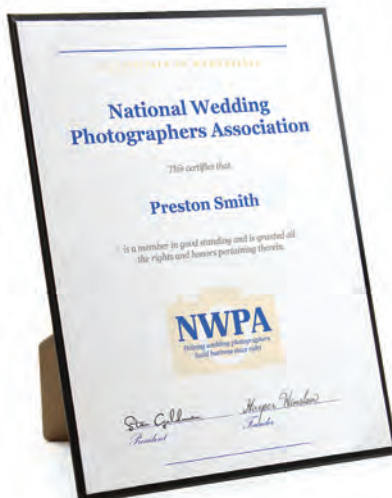

575

Premier Frame	25	50	100	250	500	1000
<b>575 Blank</b>	11.92	10.23	9.10	8.91	8.48	8.32

6A. Envelopes not included. Ships flat, not folded.



596PT-H

596PT-V

**Deckle Edge Certificate Folder**

- Accommodates 8-1/2" x 11" certificates
- Choose horizontal or vertical folder
- Available in single- or double-view
- Sturdy paper board backer inside with clear acetate protector
- Subtle black foil front cover border



**Size:** 8-7/8" x 11-1/2"

**Imprint:** 4" x 5" or up to 20 square inches

**Imprint Color:** Gold, Silver, or Black Foil

**Stock:** 20 pt. black embossed paper board

**Weight:** 18 lbs. per 100

Part Number	Orientation	Single or Double
596PT-H	Horizontal	Single
596PT-V	Vertical	Single
596PT-DBLH	Horizontal	Double
596PT-DBLV	Vertical	Double

Imprinted	50	100	250	500	1000	2500
Single View	6.92	5.70	4.85	4.41	3.64	3.02
Double View	8.04	6.93	6.07	5.63	4.87	4.24

6A. Envelopes not included. Ships flat, not folded.

Blank	50-999	1000+
Single View	4.16	2.59
Double View	5.39	3.81

2A. Envelopes not included. Ships flat, not folded.



Clear acetate protector

**Tuck Flap Certificate Folder**

- Dual corner slits accommodate an 8" x 10" or 8-1/2" x 11" certificate
- Tuck flap tab keeps folder securely closed
- Available in horizontal or vertical format



**Size:** 9-1/2" x 12"

**Imprint:** 4" x 5" or up to 20 square inches

**Imprint Color:** Gold foil stamp only

**Stock:** Burgundy, Black, Blue, Ivory, White, and Green Linen paper

**Weight:** 13 lbs. per 100



588

588	50	100	250	500	1000	2500
Imprinted	6.13	5.00	4.19	3.75	3.03	2.44

6A. Envelopes not included. Ships flat, not folded.

588	50-999	1000+
Blank	3.47	2.02

2A. Envelopes not included. Ships flat, not folded.

**Folder Orientation Options**

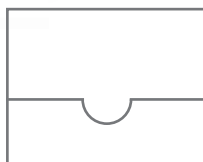

588H Flap Down

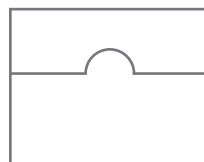

588H Flap Up

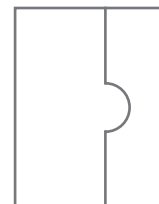

588V Flap Right

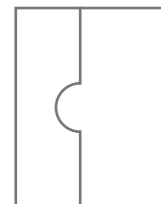

588V Flap Left

# Frames & Folders | Certificate Folders & Frames

## Mat Certificate Frame

- Accommodates 8" x 10" (568) or 8-½" x 11" (568PT) certificates
- Wide, decorative gold foil border
- Easel back and hanging tabs for horizontal or vertical display



### 568 (for 8" x 10")

**Size:** 9" x 11"  
**Imprint:** 6" x ¼"  
**Imprint Color:** Gold  
**Stock:** Black wrapped chipboard  
**Weight:** 15 lbs. per 50

### 568PT (for 8-½" x 11")

**Size:** 9-½" x 12"  
**Imprint:** 6" x ¼"  
**Imprint Color:** Gold  
**Stock:** Black wrapped chipboard  
**Weight:** 18 lbs. per 50



568

Imprinted	25	50	100	250	500	1000
568	10.25	8.86	7.84	6.66	5.77	5.22
568PT	10.97	9.54	8.32	7.03	6.31	5.43

6A

### Blank 25-499 500+

568	4.39	4.11
568PT	4.94	4.34

2A

*Envelopes not included.  
 Clear acetate protectors  
 sold separately. See  
 page 89 for details.*



566

560



## Deluxe Wrapped Edge Certificate Frame

- Accommodates 8" x 10" (560) or 8-½" x 11" (566) certificates
- Decorative gold foil border
- Easel back and hanging tabs for horizontal or vertical display
- Clear acetate protectors are included (not inserted)



### 560 (for 8" x 10")

**Size:** 10" x 12"  
**Imprint:** 6" x ½"  
**Imprint Color:** Gold  
**Stock:** Black or Blue wrapped chipboard with single border  
**Weight:** 52 lbs. per 100

### 566 (for 8-½" x 11")

**Size:** 10-¾" x 13"  
**Imprint:** 6" x ½"  
**Imprint Color:** Gold  
**Stock:** Black or Blue wrapped chipboard with double border  
**Weight:** 60 lbs. per 100

560 & 566	25	50	100	250	500	1000
Imprinted	18.87	15.01	12.72	11.80	10.52	9.50

6A. Envelopes not included.

### 560 & 566 25-499 500+

Blank	9.27	8.54
-------	------	------

2A. Envelopes not included.

**Dual Easel Certificate Frame**

- Accommodates an 8-½" x 11" certificate
- Easels and hanging tabs for horizontal or vertical display
- Clear acetate protectors available for \$0.50 (D) each



**Size:** 9-¾" x 12-¼"

**Imprint:** 6" x ½"

**Imprint Color:** Gold

**Stock:** Black – 18 pt. embossed recycled paper board  
White – 18 pt. white smooth C1S

**Weight:** 18 lbs. per 100



587PT

<b>587PT</b>	<b>50</b>	<b>100</b>	<b>250</b>	<b>500</b>	<b>1000</b>	<b>2500</b>
<b>Imprinted</b>	6.13	5.00	4.19	3.75	3.03	2.44

6A

**587PT 50-999 1000+**

<b>Blank</b>	3.47	2.02
--------------	------	------

2A

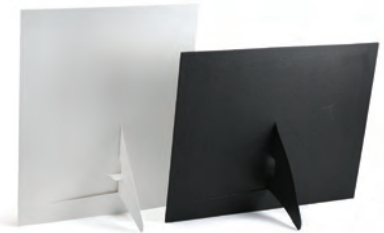

953-H

953-V

**Padded Certificate Folder**

**Size (953, 950):** 11" x 8-¾"

**Size (851, 852):** 11-½" x 9"

**Imprint:** 4" x 5" or up to 20 square inches

**Imprint Color:** Gold or Silver Foil

**Stock:** Black, Burgundy, Forest Green, and Navy Blue padded folio with subtle linen weave texture (953-V black only)

**Corners:** Gold Foil, Silver Foil, or Ribbon corners (851 & 852 have ribbon corners only with plain white back)



- Silver Foil
- Gold Foil
- Ribbon (full corners)

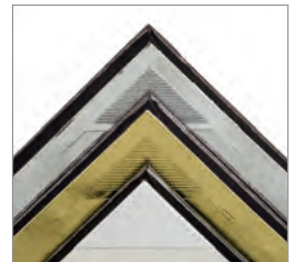

Imprinted	Accommodates	25	50	100	250	500	1000	Weight per 50
<b>953-H</b> Horz.	One 8" x 10"	26.33	20.83	18.62	16.99	15.63	14.67	34 lbs.
<b>953-V</b> Vert.	One 8" x 10"	26.33	20.83	18.62	16.99	15.63	14.67	34 lbs.
<b>950</b>	Two 8" x 10"	29.09	22.52	20.31	18.85	17.51	16.63	37 lbs.
<b>851</b>	One 8-½" x 11"	28.03	21.35	19.13	17.74	16.18	15.31	34 lbs.
<b>852</b>	Two 8-½" x 11"	30.78	23.04	20.82	19.59	18.06	17.27	34 lbs.

Blank	25-499	500+
<b>953-H</b> Horz.	14.01	13.39
<b>953-V</b> Vert.	14.01	13.39
<b>950</b>	15.90	15.36
<b>851</b>	14.57	14.04
<b>852</b>	16.48	15.96

6A. Envelopes not included.

2A. Envelopes not included.



**Product shown:**  
604 House Value Stick Calendar (p. 75)

## Calendars

Tri-Fold Calendars ..... 51-52  
 Wave Calendars ..... 53  
 Table Tents & Stock Shape Waves ..... 54-55  
 Daily Date Calendars ..... 56-57  
 Printed Desk Calendars ..... 58

Desk Calendars ..... 59-70  
 Calendar Pads & Refill Pads ..... 71  
 Truck Calendars ..... 72  
 Easy Stick™ Calendars ..... 73  
 Value Stick™ Calendars ..... 74-75

# Custom Tri-Fold Calendars



## Custom Printed Tri-Fold Calendars

- No set-up charges!
- Completely custom—use our calendar layout or design your own
- Easy to mail with included white envelopes



**Size:** 5-<sup>9</sup>/<sub>16</sub>" x 18" (open)  
5-<sup>9</sup>/<sub>16</sub>" x 7-<sup>1</sup>/<sub>4</sub>" (closed)

**Imprint:** 4-color process  
*Second-side imprint available (charges apply)*

**Stock:** Smooth white cardstock

**Weight:** 7 lbs. per 100

	1620	50	75	100	250	500	1000
<b>By 6/1</b>	3.19	2.50	2.09	1.44	1.16	1.06	
<b>After 6/1</b>	3.42	2.62	2.20	1.50	1.22	1.14	

6A. Mailing envelopes included. Not inserted. Ships flat, not folded.

Create a unique invitation for your event.



Showcase your event or business every day.

# Calendars | Tri-Fold Calendars

Order early and **SAVE!**  
Blue pricing for orders received by 6/1/26.

## Tri-Fold Calendars

- No set-up charges!
- Add your logo in full color
- Easy to mail with included white envelopes
- Choose from eight stock designs



**Size:** 5-9/16" x 18" (open)  
5-9/16" x 7-1/4" (closed)

**Imprint:** 4-1/2" x 1-1/4"

**Imprint Color:** 4-color process

**Stock:** Smooth white cardstock

**Weight:** 7 lbs. per 100

Tri-Fold	50	75	100	250	500	1000
<b>By 6/1</b>	3.19	2.50	2.09	1.44	1.16	1.06
<b>After 6/1</b>	3.42	2.62	2.20	1.50	1.22	1.14

6A. Mailing envelopes included. Not inserted. Ships flat, not folded.



1606 Wildlife



1601 Beach



1603 USA



1604 Scenic



1607 Peace



1608 Golf



1609 Color Block



1610 Custom Photo



1804 Scenic

January through June on side 1

July through December on side 2



**Wave Calendars**

- No set-up charges!
- Add your logo in full color
- Two-sided designs
- Easy to mail with included white envelopes



**Size:** 6" x 14-1/2" (open)  
5" x 6" (folded)  
**Imprint:** 1-3/4" x 5-1/2"  
**Imprint Color:** 4-color process  
**Stock:** Smooth white cardstock  
**Weight:** 7 lbs. per 100

Waves	50	75	100	250	500	1000
By 6/1	3.81	3.05	2.59	1.88	1.63	1.55
After 6/1	3.99	3.15	2.73	1.99	1.69	1.58

6A. Mailing envelopes included. Not inserted. Ships folded, not assembled.



1801 Beach



1802 USA



1808 Golf

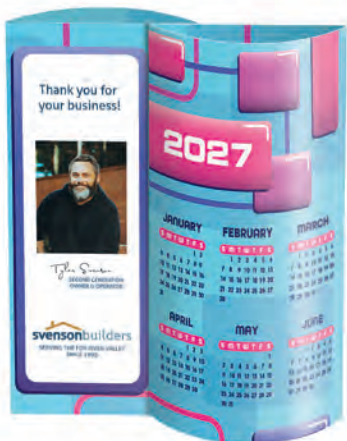

1809 Color Block



1810 Custom Photo



1811 Peace

# Calendars | Table Tents

## Custom Table Tents

- No set-up charges!
- Choose horizontal or vertical
- Quick and easy assembly



**Size:** 4-1/4" x 5-1/2" (vertical)  
7" x 4-1/4" (horizontal)

**Imprint Color:** 4-color process

**Stock:** Smooth white cardstock

**Weight:** 3 lbs. per 100 (vertical)  
4 lbs. per 100 (horizontal)



1851 Vertical



1850 Horizontal

Print weekly specials on one side.



Print your drink list or menu on the other side.

Table Tents	100	250	500	1000
1850 Horizontal	1.75	1.16	0.97	0.88
1851 Vertical	1.61	1.04	0.82	0.72

4C. Ships flat, not folded. Inside printing available for \$0.40 (C) each.



1820

Utilize the area behind the "wave" by adding extra brand elements, coupons, schedules, or specials.

## Wave Table Tents

- No set-up charges!
- Easy to mail with included envelopes



**Size:** 6" x 14-1/2" (open)  
5" x 6" (folded)

**Imprint Color:** 4-color process

**Stock:** Smooth white cardstock

**Weight:** 7 lbs. per 100



Great for bars & restaurants. Advertise specials or events.



Advertise performance or sports schedules.

Wave Table Tents	50	75	100	250	500	1000
1820	3.99	3.15	2.73	1.99	1.69	1.58

6A. Mailing envelopes included. Not inserted. Ships folded, not assembled.



1831 Scallop



1832 White Wine



1833 Red Wine

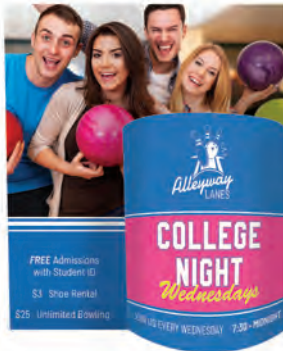

1834 Curve



1835 Block



1836 Circle

**Stock Shape Table Tents**

- No set-up charges!
- Easy to mail with included envelopes
- Perfect for printing event schedules, special menus, branding, or promotions.



**Size:** 6" x 14-1/2" (open)  
5" x 6" (folded)

**Imprint Color:** 4-color process

**Stock:** Smooth white cardstock

**Weight:** 7 lbs. per 100

1831-1837	100	250	500	1000
<b>Stock Shape Waves</b>	3.99	3.15	2.73	1.99

4A. Mailing envelopes included. Not inserted.  
Ships folded, not assembled.



Tabs are labeled and color-coded for quick and easy assembly

**1837 Wine Combo**

Red Wine Side



White Wine Side



Show a different message on each side.

Value Daily Date Calendars

- No set-up charges!
- Calendar pad begins in mid-December
- 4-color digital printing covers entire calendar front
- Metal hardware included for easy pad refill option (see p. 71).
- Punched hanging hole for wall display and wire easel for desk display
- Smooth finish standard. Embossed texture available for \$0.08 (C) each.
- Individual corrugated mailer available for \$0.40 (G)



Val Cal	100	200	300	400	500	750	1000
V33 – By 6/1	13.54	12.26	11.10	10.34	9.59	9.16	8.46
V33 – After 6/1	15.05	13.62	12.34	11.49	10.66	10.17	9.41
V43 – By 6/1	13.67	12.42	11.24	10.60	9.76	9.27	8.69
V43 – After 6/1	15.19	13.80	12.49	11.78	10.85	10.30	9.66

7A. Foil stamping not available on this item; please refer to Foil Stamped Calendars below.



V33

Size: 3-5/8" x 5-5/8"  
Pad Size: 3" x 3"  
Weight: 41 lbs. per 100

V43

Size: 4-1/4" x 7"  
Pad Size: 3" x 3"  
Weight: 42 lbs. per 100



Wire easel comes attached for easy desk display



Foil Stamped Daily Date Calendars



- Calendar pad begins in mid-December
- Hardbound book cover-like construction with wrapped edges for a rich and distinctive finish
- Imprint your logo in Gold, Silver, or Black foil
- Metal hardware included for easy pad refill option (see p. 71).
- Punched hanging hole with silver metal eyelet
- Individual corrugated mailer available for \$0.40 (G)



Foil Stamped	Back Size	Pad Size	50	100	200	300	400	500	750	1000	Weight per 100
FS083 – By 6/1	8-3/8" x 12-3/8"	3" x 3"	22.27	17.20	15.21	13.86	13.04	11.97	11.49	10.53	72 lbs.
FS083 – After 6/1	8-3/8" x 12-3/8"	3" x 3"	24.75	19.11	16.90	15.40	14.49	13.30	12.77	11.70	72 lbs.
FS084 – By 6/1	8-3/8" x 12-3/8"	4-3/4" x 4-3/4"	22.64	17.99	16.45	15.04	14.35	13.90	12.94	12.21	103 lbs.
FS084 – After 6/1	8-3/8" x 12-3/8"	4-3/4" x 4-3/4"	25.16	19.99	18.28	16.72	15.95	15.44	14.38	13.57	72 lbs.
FS086 – By 6/1	8-3/8" x 12-3/8"	6" x 5-1/2"	25.83	20.89	19.47	18.01	17.25	16.05	15.57	14.69	135 lbs.
FS086 – After 6/1	8-3/8" x 12-3/8"	6" x 5-1/2"	28.70	23.22	21.63	20.01	19.17	17.83	17.29	16.32	135 lbs.

8C. All prices include one stock foil color on standard paper. Stamping plate additional. See website for plate sizing and charges. No plate charge for exact repeat imprints within 2 years. No less than minimum available. For imprint location and sizing see our website.

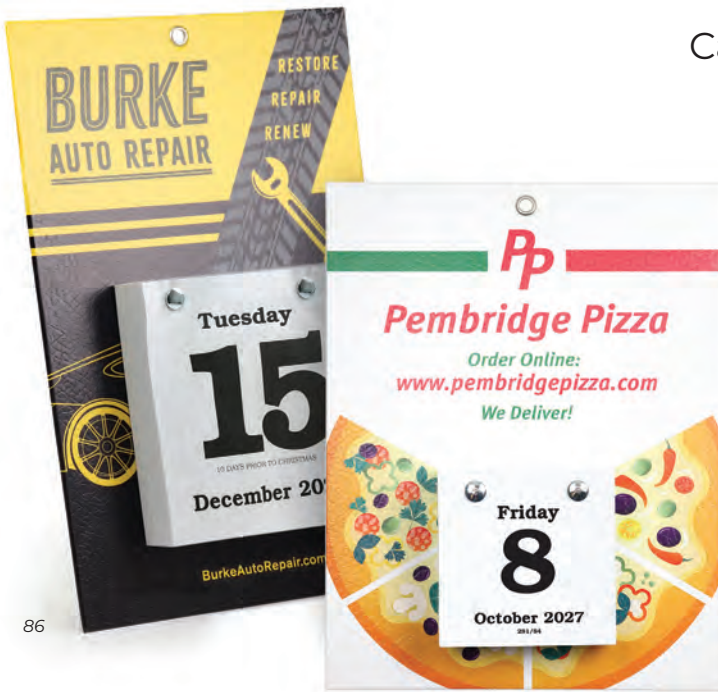

86

793

**Bookbound Daily Date Calendars**

- No set-up charges!
- Calendar pad begins in mid-December
- 4-color digital printing covers entire calendar front
- Made of sturdy bookboard material
- Wrapped edges and embossed texture for a rich and distinctive finish
- Metal hardware included for easy pad refill option (see p. 69).
- Punched hanging hole with silver metal eyelet
- Individual corrugated mailer available for \$0.40 (G)



Foil Stamped	Back Size	Pad Size	50	100	200	300	400	500	750	1000	Weight per 100
<b>793 – By 6/1</b>	7" x 9"	3" x 3"	20.60	15.57	13.97	12.61	11.49	10.91	10.39	9.54	53 lbs.
<b>793 – After 6/1</b>	7" x 9"	3" x 3"	22.89	17.29	15.53	14.01	12.77	12.12	11.54	10.60	53 lbs.
<b>794 – By 6/1</b>	7" x 9"	4-1/4" x 4-3/4"	21.34	16.76	15.08	13.70	13.11	12.26	11.71	11.07	82 lbs.
<b>794 – After 6/1</b>	7" x 9"	4-1/4" x 4-3/4"	23.71	18.62	16.76	15.22	14.56	13.62	13.01	12.30	82 lbs.
<b>73 – By 6/1</b>	7" x 11"	3" x 3"	20.90	16.42	14.35	12.99	12.21	11.25	10.75	10.42	59 lbs.
<b>73 – After 6/1</b>	7" x 11"	3" x 3"	23.23	18.25	15.95	14.44	13.57	12.50	11.94	11.58	59 lbs.
<b>74 – By 6/1</b>	7" x 11"	4-1/4" x 4-3/4"	21.90	17.21	15.78	14.29	13.46	12.56	12.06	11.37	85 lbs.
<b>74 – After 6/1</b>	7" x 11"	4-1/4" x 4-3/4"	24.33	19.13	17.53	15.88	14.96	13.95	13.40	12.64	85 lbs.
<b>76 – By 6/1</b>	7" x 11"	6" x 5-1/2"	24.85	20.05	18.56	17.32	16.61	15.62	15.04	14.23	119 lbs.
<b>76 – After 6/1</b>	7" x 11"	6" x 5-1/2"	27.61	22.27	20.62	19.24	18.45	17.36	16.72	15.81	119 lbs.
<b>83 – By 6/1</b>	8-3/8" x 12-3/8"	3" x 3"	22.31	17.19	15.21	13.86	13.04	11.98	11.49	10.53	72 lbs.
<b>83 – After 6/1</b>	8-3/8" x 12-3/8"	3" x 3"	24.79	19.10	16.90	15.40	14.49	13.31	12.77	11.70	72 lbs.
<b>84 – By 6/1</b>	8-3/8" x 12-3/8"	4-1/4" x 4-3/4"	22.64	17.99	16.45	15.04	14.35	13.90	12.94	12.21	103 lbs.
<b>84 – After 6/1</b>	8-3/8" x 12-3/8"	4-1/4" x 4-3/4"	25.16	19.99	18.28	16.72	15.95	15.44	14.38	13.57	103 lbs.
<b>86 – By 6/1</b>	8-3/8" x 12-3/8"	6" x 5-1/2"	25.83	20.89	19.47	18.01	17.25	16.05	15.57	14.69	135 lbs.
<b>86 – After 6/1</b>	8-3/8" x 12-3/8"	6" x 5-1/2"	28.70	23.22	21.63	20.01	19.17	17.83	17.29	16.32	135 lbs.
<b>104 – By 6/1</b>	10-1/2" x 14"	4-1/4" x 4-3/4"	25.85	20.56	19.20	17.15	16.54	15.47	15.08	14.41	116 lbs.
<b>104 – After 6/1</b>	10-1/2" x 14"	4-1/4" x 4-3/4"	28.72	22.84	21.33	19.05	18.38	17.19	16.76	16.01	116 lbs.
<b>106 – By 6/1</b>	10-1/2" x 14"	6" x 5-1/2"	30.28	24.73	23.23	21.71	21.03	19.06	18.45	17.99	153 lbs.
<b>106 – After 6/1</b>	10-1/2" x 14"	6" x 5-1/2"	33.65	27.48	25.81	24.13	23.37	21.18	20.50	19.99	153 lbs.

8C. Foil stamping not available on this item; please refer to Foil Stamped Calendars, page 54.

**Self-Adhesive Easel – SWE8**

- Available for Foil Stamped and Bookbound Daily Date Calendars
- 8" single wing easel
- 54 pt. chipboard
- Just peel off liner to adhere to calendar
- Packed separately, not attached



Optional 8" self-adhesive easel

Punched silver metal eyelet included



Bookbound edge detail

**No order minimum**



957-01DP

957-09DP

**957-01DP & 957-09DP**

**Imprint:** 5" x 1-7/16"  
**Pad:** 4-3/8" x 3-1/4" (Memo)  
**Size:** 5-1/4" x 5-1/2"  
**Weight:** 15 lbs. per 100



**957-01DP**  
White with White Trim



**957-09DP**  
Black with Gold Trim

<b>957-01DP</b>						
<b>957-09DP</b>	<b>150</b>	<b>250</b>	<b>500</b>	<b>1000</b>	<b>1750</b>	<b>2500</b>
<b>By 6/1</b>	4.60	4.25	3.99	3.66	3.21	2.89
<b>After 6/1</b>	5.00	4.62	4.34	3.97	3.49	3.14

4A, B, C. Mailing envelopes included. Not inserted.

**311-09DP**

**Imprint:** 5" x 1-7/16"  
**Pad:** 4-3/8" x 3-1/4" (Memo)  
**Size:** 5-1/4" x 5-1/2"  
**Weight:** 15 lbs. per 100



Black with Black Trim

<b>311-09DP</b>	<b>150</b>	<b>250</b>	<b>500</b>	<b>1000</b>	<b>1750</b>	<b>2500</b>
<b>By 6/1</b>	4.97	4.64	4.33	4.02	3.49	3.07
<b>After 6/1</b>	5.40	5.04	4.71	4.37	3.79	3.33

4A, B, C. Mailing envelopes included. Not inserted.



991-01DP

991-09DP

**315-09DP**

**Imprint:** 6-3/16" x 1-7/16"  
**Pad:** 6" x 4-3/16" (Large Memo)  
**Size:** 6-1/2" x 5-7/8"  
**Weight:** 19 lbs. per 100



Black with Black Trim

<b>315-09DP</b>	<b>150</b>	<b>250</b>	<b>500</b>	<b>1000</b>	<b>1750</b>	<b>2500</b>
<b>By 6/1</b>	6.05	5.74	5.50	5.40	4.58	4.02
<b>After 6/1</b>	6.57	6.24	5.98	5.87	4.98	4.37

4A, B, C. Mailing envelopes included. Not inserted.

**991-01DP & 991-09DP**

**Imprint:** 6-3/16" x 1-7/16"  
**Pad:** 6" x 4-3/16" (Memo)  
**Size:** 6-1/2" x 5-7/8"  
**Weight:** 19 lbs. per 100



**991-01DP**  
White with White Trim



**991-09DP**  
Black with Gold Trim

<b>991-01DP</b>						
<b>991-09DP</b>	<b>150</b>	<b>250</b>	<b>500</b>	<b>1000</b>	<b>1750</b>	<b>2500</b>
<b>By 6/1</b>	5.42	5.15	4.87	4.59	4.08	3.69
<b>After 6/1</b>	5.89	5.60	5.29	4.99	4.43	4.01

4A, B, C. Mailing envelopes included. Not inserted.



**955 – Valoy**

**Imprint:** 4-5/8" x 1-1/4"

**Pad:** 4-3/8" x 3-1/4" (Memo)

**Size:** 5-1/4" x 5-1/2"

**Weight:** 15 lbs. per 100



 White with Green Trim and Green Imprint

 White with Red Trim and Red Imprint

 White with Maroon Trim and Maroon Imprint

 White with Blue Trim and Blue Imprint

 White with Black Trim and Black Imprint

<b>955</b>	<b>150</b>	<b>250</b>	<b>500</b>	<b>1000</b>	<b>1750</b>	<b>2500</b>
<b>By 6/1</b>	4.01	3.66	3.42	3.14	2.75	2.45
<b>After 6/1</b>	4.36	3.97	3.72	3.42	2.99	2.66

4A, B, C. Mailing envelopes included. Not inserted.

**Customize your Desk Calendar**

Enjoy three imprint areas — at no extra cost  
Add custom underpad and back imprint for FREE



Year-at-a-Glance displays a full 2027 calendar. Comes standard.



Index under calendar pad comes standard



Back imprint area measures 4-5/8" wide x 1-1/4" high



Underpad imprint area measures 4-1/4" wide by 2-7/8" high



**We use recycled materials.**

Our desk calendars are made out of sturdy, recycled chipboard material (80% post-consumer waste)



**963 – Cartwright**



**Imprint:** 5" x 1"  
**Pad:** 5-3/8" x 2-5/8" (Medium Memo)  
**Size:** 6-1/8" x 4-3/8"  
**Weight:** 9 lbs. per 100

- White with Gold Imprint
- Maroon with Gold Imprint
- Navy with Gold Imprint
- Gold with Gold Imprint  
*Black imprint available on request*

<b>963</b>	<b>150</b>	<b>250</b>	<b>500</b>	<b>1000</b>	<b>1750</b>	<b>2500</b>
<b>By 6/1</b>	2.37	2.11	1.95	1.88	1.61	1.42
<b>After 6/1</b>	2.58	2.30	2.12	2.04	1.75	1.54

4A, B, C. Mailing envelopes included. Not inserted.

**757 – Versailles**



**Imprint:** 4-5/8" x 1-1/8"  
**Pad:** 4-3/8" x 3-1/4" (Memo)  
**Size:** 5-1/4" x 5-1/2"  
**Weight:** 15 lbs. per 100

- White Pearl with Blue Imprint

<b>757</b>	<b>150</b>	<b>250</b>	<b>500</b>	<b>1000</b>	<b>1750</b>	<b>2500</b>
<b>By 6/1</b>	4.35	4.00	3.71	3.39	2.95	2.62
<b>After 6/1</b>	4.73	4.35	4.04	3.68	3.21	2.85

4A, B, C. Mailing envelopes included. Not inserted.

**957 – Imperial**



**Imprint:** 4-5/8" x 1-1/4"  
**Pad:** 4-3/8" x 3-1/4" (Memo)  
**Size:** 5-1/4" x 5-1/2"  
**Weight:** 15 lbs. per 100

- White with White Trim and Gold Imprint
- Red with Black Trim and Gold Imprint
- Black with Gold Trim and Gold Imprint
- Woodgrain with Gold Trim and Gold Imprint
- Navy with Gold Trim and Gold Imprint
- Maroon with Gold Trim and Gold Imprint
- Turquoise w/White Trim and Gold or White Imprint



<b>957</b>	<b>150</b>	<b>250</b>	<b>500</b>	<b>1000</b>	<b>1750</b>	<b>2500</b>
<b>By 6/1</b>	4.32	3.98	3.69	3.37	2.95	2.62
<b>After 6/1</b>	4.70	4.33	4.01	3.66	3.21	2.85

4A, B, C. Mailing envelopes included. Not inserted.

**991 – Charter**



**Imprint:** 5-3/4" x 1-1/4"  
**Pad:** 6" x 4-3/16" (Large Memo)  
**Size:** 6-1/2" x 5-7/8"  
**Weight:** 19 lbs. per 100

- White with White Trim and Gold Imprint
- Red with Black Trim and Gold Imprint
- Woodgrain with Gold Trim and Gold Imprint
- Black with Gold Trim and Gold Imprint
- Navy with Gold Trim and Gold Imprint
- Maroon with Gold Trim and Gold Imprint
- Turquoise with White Trim and Gold or White Imprint

<b>991</b>	<b>150</b>	<b>250</b>	<b>500</b>	<b>1000</b>	<b>1750</b>	<b>2500</b>
<b>By 6/1</b>	5.14	4.86	4.56	4.30	3.86	3.41
<b>After 6/1</b>	5.59	5.28	4.96	4.68	4.19	3.71

4A, B, C. Mailing envelopes included. Not inserted.



**559 – Genoa**



**Imprint:** 4-3/4" x 1-1/4"  
**Pad:** 4-3/8" x 3-1/4" (Memo)  
**Size:** 5-1/2" x 6"  
**Weight:** 19 lbs. per 100

- White with Gold Imprint
- Green with Gold Imprint
- Woodgrain with Gold Imprint
- Wine with Gold Imprint

<b>559</b>	<b>150</b>	<b>250</b>	<b>500</b>	<b>1000</b>	<b>1750</b>	<b>2500</b>
<b>By 6/1</b>	6.04	5.82	5.53	5.29	4.68	4.24
<b>After 6/1</b>	6.56	6.32	6.01	5.75	5.09	4.61

4A, B, C. Mailing envelopes included. Not inserted.



**984 – Dominique**



**Imprint:** 5-1/2" x 1-1/8"  
**Pad:** 4-3/8" x 3-1/4" (Memo)  
**Size:** 7" x 5-1/2"  
**Weight:** 18 lbs. per 100

- White with Gold Imprint
- Black with Gold Imprint
- Woodgrain with Gold Imprint

<b>984</b>	<b>150</b>	<b>250</b>	<b>500</b>	<b>1000</b>	<b>1750</b>	<b>2500</b>
<b>By 6/1</b>	5.52	5.18	4.90	4.64	4.14	3.66
<b>After 6/1</b>	5.99	5.63	5.33	5.04	4.50	3.97

4A, B, C. Mailing envelopes included. Not inserted.

Award-winning promotional products supplier



Full-year calendar on front! Gold imprint only.



**45 – Stanley**

**Imprint:** 4-3/4" x 1-1/8"  
**Pad:** 5-1/4" x 1-5/8" (3 Month)  
**Size:** 5-3/4" x 3-1/2"  
**Weight:** 7 lbs. per 100



 White with Blue Trim and Blue Imprint

<b>45</b>	<b>150</b>	<b>250</b>	<b>500</b>	<b>1000</b>	<b>1750</b>	<b>2500</b>
<b>By 6/1</b>	3.21	2.92	2.73	2.49	2.09	1.87
<b>After 6/1</b>	3.49	3.18	2.97	2.71	2.28	2.03

4A, B, C. Mailing envelopes included. Not inserted.



**401 – Discreet**

**Imprint:** 4-3/4" x 1-1/4"  
**Pad:** 5-1/4" x 1-5/8" (3 Month)  
**Size:** 6-1/4" x 3-1/2"  
**Weight:** 5 lbs. per 100



 White with Red Trim and Red Imprint

 White with Blue Trim and Blue Imprint

<b>401</b>	<b>150</b>	<b>250</b>	<b>500</b>	<b>1000</b>	<b>1750</b>	<b>2500</b>
<b>By 6/1</b>	2.30	2.06	1.79	1.69	1.49	1.26
<b>After 6/1</b>	2.50	2.24	1.95	1.84	1.61	1.37

4A, B, C. Mailing envelopes included. Not inserted.



**137 – Ace**

**Imprint:** 4-3/4" x 1-1/4"  
**Pad:** 5-1/4" x 1-5/8" (3 Month)  
**Size:** 6-1/8" x 3-1/2"  
**Weight:** 5 lbs. per 100



 White with Gold Imprint

 Maroon with Gold Imprint

 Blue with Gold Imprint

 Green Marble with Gold Imprint

<b>137</b>	<b>150</b>	<b>250</b>	<b>500</b>	<b>1000</b>	<b>1750</b>	<b>2500</b>
<b>By 6/1</b>	2.30	2.06	1.79	1.69	1.49	1.26
<b>After 6/1</b>	2.50	2.24	1.95	1.84	1.61	1.37

4A, B, C. Mailing envelopes included. Not inserted.





**1200 – Livingston**

**Imprint:** 5" x 1-1/8"  
**Pad:** 5-1/4" x 1-5/8" (3 Month)  
**Size:** 6" x 4"  
**Weight:** 12 lbs. per 100





 White with Gold Imprint

 Green with Gold or White Imprint

 Red with Gold or White Imprint

 Blue with Gold or White Imprint

 Black with Gold or White Imprint

 Navy with Gold or White Imprint

 Wine with Gold or White Imprint

<b>1200</b>	<b>150</b>	<b>250</b>	<b>500</b>	<b>1000</b>	<b>1750</b>	<b>2500</b>
<b>By 6/1</b>	4.58	4.25	3.90	3.66	3.21	2.86
<b>After 6/1</b>	4.98	4.62	4.24	3.97	3.49	3.11

4A, B, C. Mailing envelopes included. Not inserted.



Add custom underpad and back imprint for FREE.



Year-at-a-Glance on back

**655 – Forest**

**Imprint:** 4-5/8" x 1-1/4"  
**Pad:** 4-3/8" x 3-1/4" (Memo)  
**Size:** 5-1/4" x 5-1/2"  
**Weight:** 16 lbs. per 100



MADE OUT OF RAW CHIPBOARD

- Natural Chipboard with Green Imprint
- Natural Chipboard with Maroon Imprint

- Natural Chipboard with Red Imprint
- Natural Chipboard with Blue Imprint

<b>655</b>	<b>150</b>	<b>250</b>	<b>500</b>	<b>1000</b>	<b>1750</b>	<b>2500</b>
<b>By 6/1</b>	4.01	3.66	3.42	3.14	2.75	2.45
<b>After 6/1</b>	4.36	3.97	3.72	3.42	2.99	2.66

4A, B, C. Mailing envelopes included. Not inserted.

**190 – Natural**

**Imprint:** 4-5/8" x 1-1/4"  
**Pad:** 4-3/8" x 3-1/4" (Memo)  
**Size:** 5-1/4" x 5-1/2"  
**Weight:** 15 lbs. per 100



MADE OUT OF RAW CHIPBOARD AND RECYCLED PAPER

Pumice with Dark Gray Trim and Black Imprint

Sandstone with Light Gray Trim and Gold Imprint

<b>190</b>	<b>150</b>	<b>250</b>	<b>500</b>	<b>1000</b>	<b>1750</b>	<b>2500</b>
<b>By 6/1</b>	4.53	4.23	3.86	3.61	3.08	2.74
<b>After 6/1</b>	4.93	4.60	4.19	3.92	3.34	2.98

4A, B, C. Mailing envelopes included. Not inserted.



**975 – Monterey**

**Imprint:** 4-5/8" x 1-1/4"  
**Pad:** 4-3/8" x 3-1/4" (Scenic (std) or Memo)  
**Size:** 5-1/4" x 5-3/8"  
**Weight:** 15 lbs. per 100



White with Maroon Trim and Maroon Imprint

White with Green Trim and Green Imprint

<b>975</b>	<b>150</b>	<b>250</b>	<b>500</b>	<b>1000</b>	<b>1750</b>	<b>2500</b>
<b>By 6/1</b>	4.92	4.65	4.42	4.11	3.66	3.19
<b>After 6/1</b>	5.35	5.05	4.80	4.47	3.97	3.47

4A, B, C. Mailing envelopes included. Not inserted.



# Calendars | Desk Calendars

Order early and **SAVE!**  
Blue pricing for orders received by 6/1/26.

## 449 – Naples

**Imprint:** 4-1/2" x 1-1/4"

**Pad:** 4-3/8" x 3-3/4" (Memo)

**Size:** 5" x 5-7/8"

**Weight:** 15 lbs. per 100



Index under  
calendar pad



 White with White Panel and Gold Imprint

 Blue with White Panel and Gold Imprint

 Red with White Panel and Gold Imprint



<b>449</b>	<b>150</b>	<b>250</b>	<b>500</b>	<b>1000</b>	<b>1750</b>	<b>2500</b>
<b>By 6/1</b>	5.76	5.43	5.24	4.92	4.32	3.71
<b>After 6/1</b>	6.26	5.90	5.69	5.35	4.70	4.04

4A, B, C. Mailing envelopes included. Not inserted.



## 567 – Emissary

**Imprint:** 4-1/2" x 1-1/4"

**Pad:** 4-3/8" x 3-3/4" (Memo)

**Size:** 6-3/4" x 5-1/2"

**Weight:** 23 lbs. per 100



 White with White Trim and Gold Imprint

 Red with White Trim and Gold or White Imprint

 Wine with White Trim and Gold or White Imprint

 Black with White Trim and Gold or White Imprint

<b>567</b>	<b>150</b>	<b>250</b>	<b>500</b>	<b>1000</b>	<b>1750</b>	<b>2500</b>
<b>By 6/1</b>	8.45	8.28	8.05	7.21	7.07	6.36
<b>After 6/1</b>	9.18	9.00	8.75	7.83	7.68	6.91

3A, 2B, C. Mailing envelopes included. Not inserted.

## 041 – Magna

**Imprint:** 5-1/2" x 1-1/4"

**Pad:** 6" x 4-3/16" (Large Memo)

**Size:** 6-5/8" x 6-1/4"

**Weight:** 20 lbs. per 100



Index under  
calendar pad





 Black with Black Ad Panel and Gold Imprint

 Black with Green Marble Ad Panel and Gold Imprint

 White with Green Marble Ad Panel and Gold Imprint

 White with Burgundy Marble Ad Panel and Gold Imprint

 White with White Ad Panel and Gold Imprint

 White with Blue Marble Ad Panel and Gold Imprint



<b>041</b>	<b>150</b>	<b>250</b>	<b>500</b>	<b>1000</b>	<b>1750</b>	<b>2500</b>
<b>By 6/1</b>	6.80	6.61	6.47	6.19	5.42	4.84
<b>After 6/1</b>	7.39	7.18	7.04	6.73	5.89	5.26

4A, B, C. Mailing envelopes included. Not inserted.



**217 – Ambassador**

**Imprint:** 4-3/4" x 1-1/4"   
**Pad:** 4-3/8" x 3-3/4" (Memo (std) or Scenic)  
**Size:** 5-1/8" x 5-3/4"  
**Weight:** 10 lbs. per 100

-  Red with Black Trim and Gold Imprint
-  White with Maroon Trim and Maroon Imprint

<b>217</b>	<b>150</b>	<b>250</b>	<b>500</b>	<b>1000</b>	<b>1750</b>	<b>2500</b>
<b>By 6/1</b>	4.02	3.85	3.59	3.39	2.95	2.59
<b>After 6/1</b>	4.37	4.18	3.90	3.68	3.21	2.82

4A, B, C. Mailing envelopes included. Not inserted.



**296 – Mailer**

**Imprint:** 5-3/8" x 1"   
**Pad:** 5-3/8" x 2-5/8" (Medium Memo)  
**Size:** 5-15/16" x 4-5/16"  
**Weight:** 10 lbs. per 100

-  White with Black Imprint
-  White with Blue Imprint

<b>296</b>	<b>150</b>	<b>250</b>	<b>500</b>	<b>1000</b>	<b>1750</b>	<b>2500</b>
<b>By 6/1</b>	4.04	3.72	3.44	3.20	2.79	2.47
<b>After 6/1</b>	4.39	4.05	3.74	3.48	3.03	2.68



4A, B, C. Mailing envelopes included. Not inserted.



**53 – Window Thermometer**

**Imprint:** 3-3/4" x 1"  
**Pad:** 4" x 1-5/8" (3 Month)  
**Size:** 5-7/8" x 3-5/8"  
**Weight:** 7 lbs. per 100



-  Red with White Trim and Black Imprint
-  Blue with White Trim and Black Imprint
-  Black with White Trim and Black Imprint

<b>53</b>	<b>150</b>	<b>250</b>	<b>500</b>	<b>1000</b>	<b>1750</b>	<b>2500</b>
<b>By 6/1</b>	4.28	4.00	3.81	3.61	3.19	2.80
<b>After 6/1</b>	4.66	4.35	4.14	3.92	3.47	3.04



4A, B, C. Mailing envelopes included. Not inserted.



Border around calendar pad and imprint areas comes standard

**956 – Princeton**

**Imprint:** 4-1/8" x 1"   
**Pad:** 4-3/8" x 3-1/4" (Memo)  
**Size:** 5-3/4" x 5-1/2"  
**Weight:** 15 lbs. per 100

-  Wine with Gold Imprint
-  White with Gold Imprint
-  Green with Gold Imprint

<b>956</b>	<b>150</b>	<b>250</b>	<b>500</b>	<b>1000</b>	<b>1750</b>	<b>2500</b>
<b>By 6/1</b>	4.38	4.21	3.89	3.61	3.14	2.84
<b>After 6/1</b>	4.76	4.57	4.23	3.92	3.42	3.08

4A, B, C. Mailing envelopes included. Not inserted.



**642 - Crescent**

**Imprint:** 5-1/2" x 1-1/4"  
**Pad:** 4-3/8" x 3-1/4" (Memo)  
**Size:** 6-1/8" x 5-1/2"  
**Weight:** 14 lbs. per 100

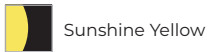

Sunshine Yellow

Matching imprint colors standard. Gold or Silver available upon request.



Orchid Purple

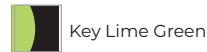

Key Lime Green

<b>642</b>	<b>150</b>	<b>250</b>	<b>500</b>	<b>1000</b>	<b>1750</b>	<b>2500</b>
<b>By 6/1</b>	4.61	4.32	4.06	3.91	3.37	3.05
<b>After 6/1</b>	5.01	4.70	4.41	4.25	3.66	3.31

4A, B, C. Mailing envelopes included. Not inserted.



**990 - Hampshire**

**Imprint:** 5-1/2" x 2"  
**Pad:** 6" x 4-3/16" (Large Memo)  
**Size:** 6-3/8" x 7-3/8"  
**Weight:** 19 lbs. per 100



White with White Trim and Gold Imprint

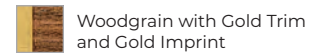

Woodgrain with Gold Trim and Gold Imprint

<b>990</b>	<b>150</b>	<b>250</b>	<b>500</b>	<b>1000</b>	<b>1750</b>	<b>2500</b>
<b>By 6/1</b>	5.29	5.03	4.77	4.53	3.90	3.51
<b>After 6/1</b>	5.75	5.46	5.19	4.93	4.24	3.82

4A, B, C. Mailing envelopes included. Not inserted.



Slide in a standard-sized business card.

**756 - Personalizer**

**Imprint:** 2-1/8" x 2-1/8"  
**Pad:** 6" x 4-3/16" (Large Memo)  
**Size:** 6-3/8" x 7-3/8"  
**Weight:** 19 lbs. per 100

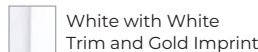

White with White Trim and Gold Imprint

<b>756</b>	<b>150</b>	<b>250</b>	<b>500</b>	<b>1000</b>	<b>1750</b>	<b>2500</b>
<b>By 6/1</b>	5.30	5.08	4.82	4.54	3.94	3.56
<b>After 6/1</b>	5.76	5.53	5.24	4.94	4.28	3.87

4A, B, C. Mailing envelopes included. Not inserted.



**233 - Norfolk**

**Imprint:** 5" x 1-1/4"  
**Pad:** 5-1/4" x 1-5/8" (3 Month)  
**Size:** 6" x 3-5/8"  
**Weight:** 10 lbs. per 100

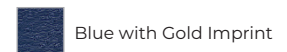

Blue with Gold Imprint

<b>233</b>	<b>150</b>	<b>250</b>	<b>500</b>	<b>1000</b>	<b>1750</b>	<b>2500</b>
<b>By 6/1</b>	4.02	3.85	3.59	3.39	2.95	2.59
<b>After 6/1</b>	4.37	4.18	3.90	3.68	3.21	2.82

4A, B, C. Mailing envelopes included. Not inserted.



**210 – Midas**  
**310 – Perry**

**Imprint:** 4-3/4" x 1-1/8"  
**Pad:** 5-1/4" x 1-5/8" (3 Month)  
**Size:** 5-3/4" x 3-1/2"  
**Weight:** 10 lbs. per 100



**210** Gold with Black Trim and Gold Imprint  
Black imprint available upon request

**310** Black with Black Trim and Gold Imprint

	150	250	500	1000	1750	2500
<b>210 &amp; 310</b>	<b>150</b>	<b>250</b>	<b>500</b>	<b>1000</b>	<b>1750</b>	<b>2500</b>
<b>By 6/1</b>	3.82	3.52	3.35	2.92	2.58	2.30
<b>After 6/1</b>	4.15	3.83	3.64	3.18	2.80	2.50

4A, B, C. Mailing envelopes included. Not inserted.



**211 – Crest**  
**311 – Putnam**

**Imprint:** 4-5/8" x 1-1/4"  
**Pad:** 4-3/8" x 3-1/4" (Memo)  
**Size:** 5-1/4" x 5-1/2"  
**Weight:** 15 lbs. per 100



**211** Gold with Black Trim and Gold Imprint  
Black imprint available upon request

**311** Black with Black Trim and Gold Imprint

	150	250	500	1000	1750	2500
<b>211 &amp; 311</b>	<b>150</b>	<b>250</b>	<b>500</b>	<b>1000</b>	<b>1750</b>	<b>2500</b>
<b>By 6/1</b>	4.68	4.34	4.03	3.72	3.24	2.86
<b>After 6/1</b>	5.08	4.72	4.38	4.05	3.52	3.11

4A, B, C. Mailing envelopes included. Not inserted.



**214 – Crown**  
**314 – Madison**

**Imprint:** 4-3/4" x 1-1/8"  
**Pad:** 4-3/8" x 3-1/4" (Memo)  
**Size:** 5-1/2" x 6"  
**Weight:** 19 lbs. per 100



**214** Gold with Gold Imprint  
Black imprint available upon request

**314** Black with Gold Imprint

	150	250	500	1000	1750	2500
<b>214 &amp; 314</b>	<b>150</b>	<b>250</b>	<b>500</b>	<b>1000</b>	<b>1750</b>	<b>2500</b>
<b>By 6/1</b>	6.26	5.97	5.79	5.59	4.96	4.33
<b>After 6/1</b>	6.80	6.49	6.29	6.08	5.39	4.71

4A, B, C. Mailing envelopes included. Not inserted.



**215 – Klondike**  
**315 – Pike**

**Imprint:** 5-3/4" x 1-3/4"  
**Pad:** 6" x 4-3/16" (Large Memo)  
**Size:** 6-1/2" x 5-7/8"  
**Weight:** 19 lbs. per 100



**215** Gold with Black Trim and Gold Imprint  
Black imprint available upon request

**315** Black with Black Trim and Gold Imprint

	150	250	500	1000	1750	2500
<b>215 &amp; 315</b>	<b>150</b>	<b>250</b>	<b>500</b>	<b>1000</b>	<b>1750</b>	<b>2500</b>
<b>By 6/1</b>	5.77	5.44	5.23	5.01	4.31	3.78
<b>After 6/1</b>	6.27	5.91	5.68	5.44	4.69	4.11

4A, B, C. Mailing envelopes included. Not inserted.



**42 – Monarch**

**Imprint:** 5" x 1-1/8"  
**Pad:** 5-1/4" x 1-5/8" (3 Month)  
**Size:** 5-3/4" x 3-1/2"  
**Weight:** 10 lbs. per 100



Year-at-a-Glance on back

-  White with Green Trim and Green Imprint
-  White with Red Trim and Red Imprint
-  White with Maroon Trim and Maroon Imprint
-  White with Blue Trim and Blue Imprint

<b>42</b>	<b>150</b>	<b>250</b>	<b>500</b>	<b>1000</b>	<b>1750</b>	<b>2500</b>
<b>By 6/1</b>	3.21	2.92	2.73	2.49	2.09	1.87
<b>After 6/1</b>	3.49	3.18	2.97	2.71	2.28	2.03

4A, B, C. Mailing envelopes included. Not inserted.

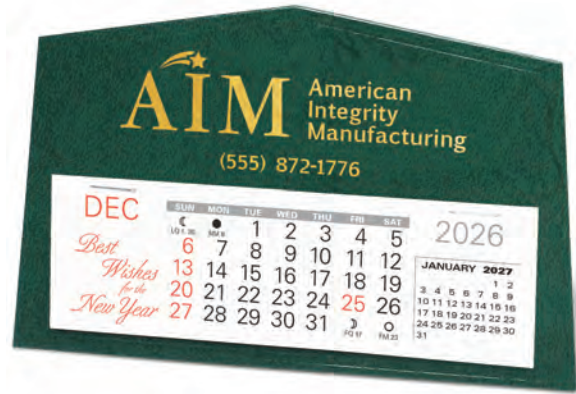





**949 – Athens**

**Imprint:** 4-5/8" x 1-1/8"  
**Pad:** 5-1/4" x 1-5/8" (3 Month)  
**Size:** 6-1/2" x 3-3/4"  
**Weight:** 7 lbs. per 100



Edge detail

-  White with Gold Imprint
-  Green with Gold Imprint
-  Wine with Gold Imprint
-  Navy with Gold Imprint

<b>949</b>	<b>150</b>	<b>250</b>	<b>500</b>	<b>1000</b>	<b>1750</b>	<b>2500</b>
<b>By 6/1</b>	2.43	2.26	2.03	1.89	1.67	1.48
<b>After 6/1</b>	2.64	2.45	2.20	2.06	1.81	1.60





4A, B, C. Mailing envelopes included. Not inserted.



**958 – Budget Special**

**Imprint:** 4-5/8" x 1-1/4"  
**Pad:** 5-1/4" x 1-5/8" (3 Month)  
**Size:** 5-3/4" x 3-7/8"  
**Weight:** 7 lbs. per 100



-  White with Gold Imprint
-  Red with Gold or White Imprint
-  Blue with Gold or White Imprint
-  Woodgrain with Gold or White Imprint

<b>958</b>	<b>150</b>	<b>250</b>	<b>500</b>	<b>1000</b>	<b>1750</b>	<b>2500</b>
<b>By 6/1</b>	2.32	2.06	1.92	1.83	1.60	1.38
<b>After 6/1</b>	2.53	2.24	2.09	1.99	1.74	1.50





4A, B, C. Mailing envelopes included. Not inserted.



**52 – Window**

**Imprint:** 4-1/2" x 1-1/8"  
**Pad:** 5-1/4" x 1-5/8" (3 Month)  
**Size:** 5-7/8" x 3-13/16"  
**Weight:** 6 lbs. per 100



-  Blue with White Trim and Black Imprint
-  Red with White Trim and Black Imprint
-  Black with White Trim and Black Imprint
-  Woodgrain with Cream Trim and Black Imprint

<b>52</b>	<b>150</b>	<b>250</b>	<b>500</b>	<b>1000</b>	<b>1750</b>	<b>2500</b>
<b>By 6/1</b>	3.21	2.92	2.73	2.49	2.09	1.87
<b>After 6/1</b>	3.49	3.18	2.97	2.71	2.28	2.03

4A, B, C. Mailing envelopes included. Not inserted.







**101 – Citation II**



**Imprint:** 4-1/2" x 1-1/4"  
**Pad:** 4-3/8" x 3-1/4" (Memo (std) or Scenic)  
**Size:** 5-1/4" x 5-3/4"  
**Weight:** 15 lbs. per 100



-  Blue with Gold Imprint
-  Green with Gold Imprint
-  White with Gold Imprint
-  Maroon with Gold Imprint
-  Black with Gold Imprint

Index under calendar pad

<b>101</b>	<b>150</b>	<b>250</b>	<b>500</b>	<b>1000</b>	<b>1750</b>	<b>2500</b>
<b>By 6/1</b>	5.61	5.32	5.08	4.90	4.26	3.75
<b>After 6/1</b>	6.10	5.79	5.52	5.33	4.63	4.08

4A, B, C. Mailing envelopes included. Not inserted.

**402 – Prudent**



**Imprint:** 4-5/8" x 1-1/4"  
**Pad:** 4-3/8" x 3-1/4" (Memo)  
**Size:** 5-1/4" x 5-1/2"  
**Weight:** 10 lbs. per 100



Index under calendar pad

-  White with Red Trim and Red Imprint
-  White with Blue Trim and Blue Imprint
-  White with White Trim and Black Imprint

<b>402</b>	<b>150</b>	<b>250</b>	<b>500</b>	<b>1000</b>	<b>1750</b>	<b>2500</b>
<b>By 6/1</b>	4.00	3.76	3.26	2.78	2.54	2.18
<b>After 6/1</b>	4.34	4.09	3.55	3.02	2.76	2.36

2A, B, 2C, D. Mailing envelopes included. Not inserted.



Item #402 is 2A, B, 2C, D.







Index under calendar pad

**077 – Pacemaker**



**Imprint:** 4-3/4" x 1-1/4"  
**Pad:** 4-3/8" x 3-1/4" (Memo)  
**Size:** 5-1/8" x 5-3/4"  
**Weight:** 10 lbs. per 100

-  Blue with Gold Imprint
-  Maroon with Gold Imprint
-  White with Gold Imprint
-  Woodgrain with Gold Imprint

<b>077</b>	<b>150</b>	<b>250</b>	<b>500</b>	<b>1000</b>	<b>1750</b>	<b>2500</b>
<b>By 6/1</b>	2.65	2.33	2.11	2.03	1.74	1.55
<b>After 6/1</b>	2.88	2.54	2.30	2.20	1.89	1.69

4A, B, C. Mailing envelopes included. Not inserted.





**125 – Economizer**



**Imprint:** 5-1/2" x 1"  
**Pad:** 5-3/4" x 1-5/8" (3 Month)  
**Size:** 6" x 3-3/8"  
**Weight:** 5 lbs. per 100

- White Smooth with Gold Imprint
- Silver Metallic with Black Imprint
- Blue Marble with Gold Imprint



**403 – Vigilant**



**Imprint:** 5-3/4" x 1-3/8"  
**Pad:** 6" x 4-3/16" (Large Memo)  
**Size:** 6-1/2" x 5-7/8"  
**Weight:** 20 lbs. per 100

- White with White Trim and Black Imprint
- White with Red Trim and Red Imprint
- White with Blue Trim and Blue Imprint

<b>125</b>	<b>150</b>	<b>250</b>	<b>500</b>	<b>1000</b>	<b>1750</b>	<b>2500</b>
<b>By 6/1</b>	2.30	2.06	1.79	1.69	1.49	1.26
<b>After 6/1</b>	2.50	2.24	1.95	1.84	1.61	1.37

<b>403</b>	<b>150</b>	<b>250</b>	<b>500</b>	<b>1000</b>	<b>1750</b>	<b>2500</b>
<b>By 6/1</b>	4.02	3.85	3.59	3.39	2.95	2.59
<b>After 6/1</b>	4.37	4.18	3.90	3.68	3.21	2.82

4A, B, C. Mailing envelopes included. Not inserted.

4A, B, C. Mailing envelopes included. Not inserted.



**123 – Medalist**



**Imprint:** 5-1/2" x 1"  
**Pad:** 5-3/8" x 2-5/8" (Medium Memo)  
**Size:** 6-1/16" x 4-7/8"  
**Weight:** 10 lbs. per 100

- Dark Brown with Gold Imprint
- Maroon with Gold Imprint
- White with Gold Imprint
- Blue with Gold Imprint

<b>123</b>	<b>150</b>	<b>250</b>	<b>500</b>	<b>1000</b>	<b>1750</b>	<b>2500</b>
<b>By 6/1</b>	5.61	5.32	5.08	4.90	4.26	3.75
<b>After 6/1</b>	6.10	5.79	5.52	5.33	4.63	4.08

4A, B, C. Mailing envelopes included. Not inserted.



**024 – Daytona**



**Imprint:** 5-1/4" x 1"  
**Pad:** 4" x 1-5/8" (3 Month)  
**Size:** 6-3/8" x 4-1/4"  
**Weight:** 10 lbs. per 100

- Charcoal with Silver Trim and Silver Imprint



Visor clips are included. Not inserted.

<b>024</b>	<b>150</b>	<b>250</b>	<b>500</b>	<b>1000</b>	<b>1750</b>	<b>2500</b>
<b>By 6/1</b>	4.02	3.85	3.59	3.39	2.95	2.59
<b>After 6/1</b>	4.37	4.18	3.90	3.68	3.21	2.82

4A, B, C. Mailing envelopes included. Not inserted. Mailing box available. Please contact us for pricing.



**#20 – Small Pad**  
13 Months 3" x 2-1/4"



**#20S – Small Spanish Pad**  
13 Months 3" x 2-1/4"



**#31 – Scenic Pad**  
13 Months 4-3/8" x 3-1/4"



**#36 – Memo Pad**  
13 Months 4-3/8" x 3-1/4"



**#73 – 3 Month Pad**  
13 Months 5-1/4" x 1-5/8"



**#80 – 3 Month Pad**  
13 Months 4" x 1-5/8"



**#37 – Large Memo Pad**  
13 Months 6" x 4-3/16"



**#196 – Medium Memo Pad**  
13 Months 5-3/8" x 2-5/8"

**Daily Date Refill Pads**

- Calendar pads begin in mid-December
- Pads are individually shrink wrapped
- Custom hole punches not available



**33R**

**Hole Spacing:** 1-3/4"

**Pad Size:** 3" x 3"

**Weight:** 27 lbs. per 100

Refill Pads	50	100	500	750	1000
<b>33R</b> – By 6/1	5.40	5.12	4.95	4.80	4.71
<b>33R</b> – After 6/1	6.00	5.69	5.50	5.33	5.24
<b>45R</b> – By 6/1	6.49	6.37	6.27	6.12	6.02
<b>45R</b> – After 6/1	7.21	7.08	6.97	6.80	6.69
<b>66R</b> – By 6/1	9.60	9.23	8.97	8.86	8.64
<b>66R</b> – After 6/1	10.67	10.26	9.97	9.84	9.59

5C



**45R**

**Hole Spacing:** 2-3/4"

**Pad Size:** 4-1/4" x 4-3/4"

**Weight:** 54 lbs. per 100



**66R**

**Hole Spacing:** 4-1/2"

**Pad Size:** 6" x 5-1/2"

**Weight:** 85 lbs. per 100

**Truck & Ambulance Calendars**

- Four truck styles plus and ambulance
- Easel pops out for easy desk or counter display
- No set-up charges!

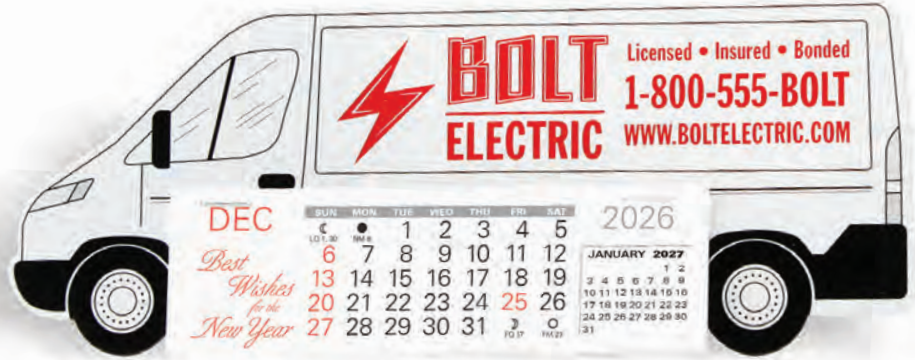

**Imprint Color:** Red (420-425), Blue (431)  
**Truck Color:** White with black trim & tires  
**Pad:** 5-3/4" x 1-5/8" (3 Month)  
**Weight:** 12 lbs. per 100

**420 – Service Van**  
Measures 8-4/8" x 3-3/8"

420-425	150	250	500	1000	1750	2500
<b>By 6/1</b>	4.19	3.87	3.57	3.25	2.80	2.49
<b>After 6/1</b>	4.55	4.20	3.88	3.53	3.04	2.70

4A, B, C. Mailing envelopes included. Not inserted.

431	150	250	500	1000	1750	2500
<b>By 6/1</b>	4.65	4.23	3.93	3.57	3.16	2.77
<b>After 6/1</b>	5.05	4.60	4.27	3.88	3.44	3.01

4A, B, C. Mailing envelopes included. Not inserted.  
Red stripe and lights standard.



**422 – Box Van**  
Measures 8-3/4" x 4-1/8"



**423 – Tractor Trailer**  
Measures 8-3/8" x 3-3/4"



**425 – Long Van**  
Measures 8-3/4" x 4"



**431 – Ambulance**  
Measures 9" x 4"



**Full-Color Truck Calendars**

- Printed before die cutting to allow full bleed
- Any truck shape can be custom printed
- Want a custom truck shape? We can do that. **Please call for details.**



**Imprint Color:** 4-color process  
**Pad:** 5-3/4" x 1-5/8" (3 Month)  
**Weight:** 12 lbs. per 100

	500	1000	1750	2500
<b>By 6/1</b>	5.56	4.60	3.71	3.30
<b>After 6/1</b>	6.04	5.00	4.04	3.59

2A, B, C. Mailing envelopes included. Not inserted.



**702 – Universal**

Size: 3-½" x 4-½"

Pad: 3" x 2-¼" *Spanish Pad Available*

Imprint: 2-¾" x 1-½"



**704 – House**

Size: 4-5/8" x 3-3/4"

Pad: 4" x 1-5/8"

Imprint: 4" x 1"

**Easy Stick™ Calendars**

- No set-up charges!
- Standard pad has 13 months
- Spanish pad available (*select calendars*)
- FREE underpad imprint! (*select calendars*)
- Comes with a Counter Top Display Box
- **Weight:** 4 lbs. per 100



	150	250	500	1000	1750	2500
<b>By 6/1</b>	1.61	1.51	1.48	1.38	1.23	1.10
<b>After 6/1</b>	1.75	1.65	1.60	1.50	1.34	1.20

4A, B, C. Mailing envelopes **not included**. Available for \$0.20 (D) each. Custom die-cut calendars are available. 1000-piece minimum. \$428.40 (D) die charge.



**705 – Truck**

Size: 4-¾" x 3-7/8"

Pad: 4" x 1-5/8"

Imprint: 2-½" x 1-¼"



**706 – Horizon**

Size: 4-½" x 3-3/8"

Pad: 4" x 1-5/8"

Imprint: 4" x 1-3/8"



**713 – Semi-Truck**

Size: 4-5/8" x 3-7/8"

Pad: 4" x 1-5/8"

Imprint: 3-¼" x 1"

**Color Options & Extras**

2-color imprints available in standard foil colors. Non-standard color combinations will incur a set-up charge. Assorted colors and special color matches are not available.

-  **Black**  
Imprint: Gold or White
-  **Maroon**  
Imprint: Gold or White
-  **Dark Blue**  
Imprint: Gold or White
-  **White**  
Imprint: Gold or Black
-  **Red**  
Imprint: Gold or White
-  **Blue**  
Imprint: Gold or White



**712 – Mug**

Size: 3-½" x 5"

Pad: 3" x 2-¼" *Spanish Pad Available*

Imprint: 2-½" x 2-¾"

*Underpad imprint not available*



**711 – Mortar & Pestle**

Size: 3" x 5-¾"

Pad: 3" x 2-¼" *Spanish Pad Available*

Imprint: 1-¾" x 2-¾"

*Underpad imprint not available*

**Value Stick™ Calendars**

- No set-up charges!
- Standard pad has 13 months
- Spanish pad available
- **Weight:** 4 lbs. per 100



**602 – Traditional**

**Size:** 3" x 4-1/2"  
**Imprint:** 2-3/4" x 2"



**602-50 – Patriotic**

**Size:** 3" x 4-1/2"  
**Imprint:** 2-3/4" x 1"



**616 – Thank You**

**Size:** 3" x 4-1/2"  
**Imprint:** 2-3/4" x 1"

	150	250	500	1000	1750	2500
<b>By 6/1</b>	1.21	1.18	1.15	1.05	0.94	0.83
<b>After 6/1</b>	1.31	1.28	1.25	1.14	1.02	0.90

4A, B, C. Mailing envelopes **not included**. Available for \$0.20 (D) each.



**614 – Semi**

**Size:** 3" x 4-3/8"  
**Imprint:** 2-1/2" x 7/8"



**633 – Ribbon**

**Size:** 3" x 4-1/2"  
**Imprint:** 1-3/4" x 1-5/8"



**613 – Truck**

**Size:** 3" x 4-1/4"  
**Imprint:** 2" x 1"



**632 – Circle**

**Size:** 3" x 4-1/2"  
**Imprint:** 1-7/8" x 1-7/8"



**627 – USA**

**Size:** 3" x 4-1/2"  
**Imprint:** 2" x 1"



**603 – Number One**

**Size:** 3" x 4-1/2"  
**Imprint:** 1-7/8" x 1-5/8"



**604 – House**

**Size:** 3" x 4-1/2"  
**Imprint:** 2-1/2" x 1"



**607 – Spotlight**

**Size:** 3" x 4-1/2"  
**Spotlight Imprint:** 7/8" x 7/8"  
**Bottom Imprint:** 2-3/4" x 1"



**615 – Wrecker**

**Size:** 3" x 4-1/2"  
**Imprint:** 2-1/2" x 7/8"

**Vinyl Swatches & Imprint Colors**



**Black**  
Imprint: Gold or White



**Blue**  
Imprint: Gold or White



**Red**  
Imprint: Gold, Black, or White



**White**  
Imprint: Gold, Black, or Pink



**Dark Blue**  
Imprint: Gold or White



**Maroon**  
Imprint: Gold, Black, or White



**Display Made Easy.**

We ship our Value Stick™ Calendars in a convenient Counter Top Display.

**2- and 3-Color Imprints**

Boost your branding with affordable 2- or 3-color imprints. For best results, use White vinyl stock.



**2-Color imprint – \$0.18 (A) each**



**3-Color imprint – \$0.34 (A) each**



**Custom Value Stick™ Calendars**

Take your branding further. Personalize your Value Stick™ calendar with a one-of-a-kind, custom shape.

- Minimum quantity of 1,000
- Please contact us for die charge pricing
- Calendar shown here is an idea only (not stock)



**Product shown:**  
**4039** Thank You Card (p. 83)

## Greeting Cards

Custom Printed Cards .....	77	Just Because Cards .....	85
Birthday Cards .....	78-80	Congratulations Cards .....	86
Anniversary Cards .....	80	Everyday Card Sentiments .....	87
Welcome Cards .....	81	Holiday Greeting Cards.....	88-90
Thank You Cards .....	82-83	Holiday Card Sentiments.....	91
Sympathy Cards.....	84	Hanukkah & Rosh Hashanah.....	92



**Custom Printed Cards**

- No set-up charges!
- Easy to mail with included envelopes
- Great for holidays, birthdays, or your next marketing campaign
- Digitally printed (4-color process)
- Printed on smooth white cardstock



Part Number		50	75	100	500	1000	Weight per 100
<b>5000-DP</b>	5" x 7" Folded	3.11	2.78	2.56	2.50	2.36	6 lbs.
<b>A2-DP</b>	4-3/4" x 5-1/2" Folded	3.11	2.78	2.56	2.50	2.36	5 lbs.
<b>8000-DP</b>	3-1/2" x 5" Folded	2.58	2.35	2.17	2.12	2.01	3 lbs.
<b>8000-DP-57</b>	5" x 7" Flat	2.58	2.35	2.17	2.12	2.01	3 lbs.
<b>4000-DP</b>	4" x 6" Folded	3.11	2.78	2.56	2.50	2.36	4 lbs.
<b>8000-DP-46</b>	4" x 6" Flat	2.58	2.78	2.56	2.50	2.36	2 lbs.

5A. Mailing envelopes included. Not inserted. Folded cards ship flat.

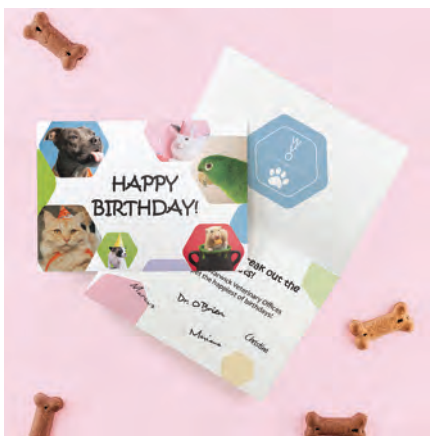
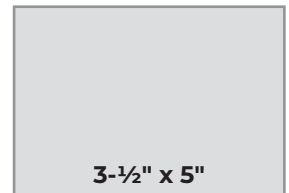
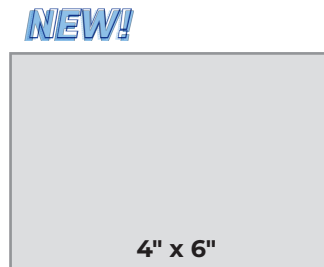
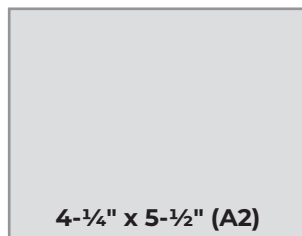

**Unlimited possibilities.**

Design your own custom branded greeting cards or marketing mailers. Custom sizing and paper stock options are available. Please contact us for details.



**9023** • 5" x 7"  
**Imprint:** Silver Foil  
**Stock:** Smooth White



**Want recycled cards?**  
 Just look for this icon.

**NEW!**



**9037** • 5" x 7"   
**Imprint:** Silver Foil  
**Stock:** Uncoated White

**NEW!**



**4052** • 5" x 7" (shown), A2, 3-½" x 5"   
**Imprint:** Printed in 1-4 Color  
**Stock:** Uncoated White

**NEW!**



**4020** • 5" x 7" (shown), A2, 3-½" x 5"  
**Imprint:** Printed in 1-4 Color  
**Stock:** Smooth White



**4056** • 5" x 7" (shown), A2, 3-½" x 5"   
**Imprint:** Printed in 1-4 Color  
**Stock:** Uncoated White



**4035** • 5" x 7", A2 (shown), 3-½" x 5"  
**Imprint:** Printed in 1-4 Color  
**Stock:** Smooth White



**4008** • 5" x 7", A2 (shown), 3-1/2" x 5"  
**Imprint:** Printed in 1-4 Color  
**Stock:** Smooth White



**4025** • 5" x 7", A2, 3-1/2" x 5" (shown)  
**Imprint:** Printed in 1-4 Color  
**Stock:** Smooth White



	50	75	100	500	1000
<b>3-1/2" x 5"</b>	2.49	2.26	2.05	1.99	1.84
<b>A2</b>	3.13	2.82	2.58	2.49	2.38
<b>5" x 7"</b>	3.13	2.82	2.58	2.49	2.38

5A. Mailing envelopes included. Not inserted.



**4017** • 5" x 7" (shown), A2, 3-1/2" x 5"  
**Imprint:** Printed in 1-4 Color  
**Stock:** Smooth White



**9012** • 5" x 7"   
**Imprint:** Gold Foil  
**Stock:** Uncoated White



**9025** • 5" x 7"  
**Imprint:** Silver Foil  
**Stock:** Smooth White

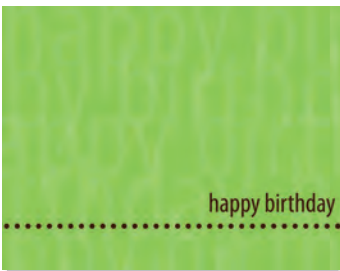

**4018** • 5" x 7", A2 (shown), 3-1/2" x 5"  
**Imprint:** Printed in 1-4 Color  
**Stock:** Smooth White



**4026** • 5" x 7", A2 (shown), 3-1/2" x 5"  
**Imprint:** Printed in 1-4 Color  
**Stock:** Smooth White



**9010** • 5" x 7"   
**Imprint:** Gold Foil  
**Stock:** Uncoated White



**9015** • 5" x 7"  
**Imprint:** Gold Foil  
**Stock:** Smooth White



**9016** • 5" x 7"  
**Imprint:** Silver Foil  
**Stock:** Smooth White



**4019** • 5" x 7", A2 (shown), 3-1/2" x 5"  
**Imprint:** Printed in 1-4 Color  
**Stock:** Smooth White



# Cards | Birthday & Anniversary Cards



**4007** • 5" x 7" (shown), A2, 3-1/2" x 5"  
**Imprint:** Printed in 1-4 Color  
**Stock:** Smooth White



**9005** • 5" x 7"   
**Imprint:** Gold Foil  
**Stock:** Uncoated White



**9006** • 5" x 7"   
**Imprint:** Copper or Gold Foil  
**Stock:** Uncoated White



**9028** • 5" x 7"   
**Imprint:** Gold Foil  
**Stock:** Kraft



**8002** • 3-1/2" x 5"   
**Imprint:** Gold Foil  
**Stock:** Uncoated White

	50	75	100	500	1000
3-1/2" x 5"	2.49	2.26	2.05	1.99	1.84
A2	3.13	2.82	2.58	2.49	2.38
5" x 7"	3.13	2.82	2.58	2.49	2.38

5A. Mailing envelopes included. Not inserted.



**4049** • 5" x 7" (shown), A2, 3-1/2" x 5"  
**Imprint:** Printed in 1-4 Color  
**Stock:** Pearlescent



**7516** • A2 (4-1/4" x 5-1/2")  
**Imprint:** Gold Foil  
**Stock:** Smooth White



**8011** • 3-1/2" x 5"   
**Imprint:** Gold Foil  
**Stock:** Uncoated White





**4044** • 5" x 7" (shown), A2, 3-½" x 5"  
**Imprint:** Printed in 1-4 Color   
**Stock:** Kraft

*Imprint may appear a different shade on this paper.*



**9035** • 5" x 7"  
**Imprint:** Silver Foil  
**Stock:** Sky Blue Metallic



**4043** • 5" x 7", A2 (shown), 3-½" x 5"  
**Imprint:** Printed in 1-4 Color  
**Stock:** Pearlescent 



**7519** • A2 (4-¼" x 5-½")  
**Imprint:** Gold Foil  
**Stock:** Smooth White   
*Also available in Teal (7518) or White (7517)*

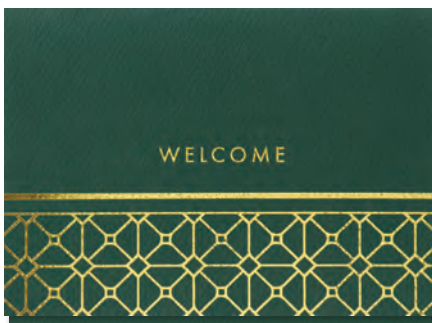



**9031** • 5" x 7"   
**Imprint:** Gold Foil  
**Stock:** Green Felt (*inside is Green*)



**4011** • 5" x 7" (shown), A2, 3-½" x 5"  
**Imprint:** Printed in 1-4 Color   
**Stock:** Smooth White



**4048** • 5" x 7" (shown), A2, 3-½" x 5"   
**Imprint:** Printed in 1-4 Color  
**Stock:** Uncoated White 



**9034** • 5" x 7"  
**Imprint:** Black Foil  
**Stock:** Smooth White

	50	75	100	500	1000
<b>3-½" x 5"</b>	2.49	2.26	2.05	1.99	1.84
<b>A2</b>	3.13	2.82	2.58	2.49	2.38
<b>5" x 7"</b>	3.13	2.82	2.58	2.49	2.38

5A. Mailing envelopes included. Not inserted.



**8026** • 3-½" x 5"   
**Imprint:** Silver Foil  
**Stock:** Uncoated White (inside is White)



**4028** • 5" x 7", A2, 3-½" x 5" (shown)  
**Imprint:** Printed in 1-4 Color  
**Stock:** Smooth White 



**8042** • 3-½" x 5"  
**Imprint:** Gold Foil  
**Stock:** Pearlescent

**4027** • 5" x 7", A2, 3-½" x 5" (shown)  
**Imprint:** Printed in 1-4 Color   
**Stock:** Smooth White



**8004** • 3-½" x 5"   
**Imprint:** Gold Foil  
**Stock:** Uncoated White (inside is White)



**7514 (Blue), 7513 (Maroon)**   
 A2 (4-¼" x 5-½")  
**Imprint:** Gold Foil  
**Stock:** Uncoated White (inside is White)

**NEW!**



**7520** • A2 (4-¼" x 5-½")  
**Imprint:** Silver Foil  
**Stock:** Pearlescent



**7505** • A2 (4-¼" x 5-½")   
**Imprint:** Gold Foil  
**Stock:** Smooth White *Also available in Teal (7506)*



# Cards | Sympathy Cards



**8028** • 3-½" x 5"   
**Imprint:** Gold Foil   
**Stock:** Ivory Felt (*inside is Ivory*)



**9030** • 5" x 7"   
**Imprint:** Silver Foil   
**Stock:** Uncoated White



**4046** • 5" x 7", A2, 3-½" x 5" (shown)   
**Imprint:** Printed in 1-4 Color   
**Stock:** White Felt

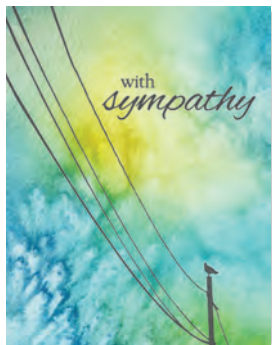

**4010** • 5" x 7", A2 (shown), 3-½" x 5"   
**Imprint:** Printed in 1-4 Color   
**Stock:** Smooth White



**4029** • 5" x 7", A2, 3-½" x 5" (shown)   
**Imprint:** Printed in 1-4 Color   
**Stock:** Smooth White   
*Inside is White. Also available in Wine.*



**4009** • 5" x 7", A2, 3-½" x 5" (shown)   
**Imprint:** Printed in 1-4 Color   
**Stock:** Smooth White



**9036** • 5" x 7"   
**Imprint:** Gold Foil   
**Stock:** Uncoated White



**4038** • 5" x 7", A2, 3-½" x 5" (shown)   
**Imprint:** Printed in 1-4 Color   
**Stock:** Kraft   
*Imprint may appear a different shade on this paper.*



**4040** • 5" x 7", A2 (shown), 3-½" x 5"   
**Imprint:** Printed in 1-4 Color   
**Stock:** Uncoated White

**8010** • 3-½" x 5"   
**Imprint:** Silver Foil   
**Stock:** Uncoated White (*inside is White*)



	50	75	100	500	1000
3-½" x 5"	2.49	2.26	2.05	1.99	1.84
A2	3.13	2.82	2.58	2.49	2.38
5" x 7"	3.13	2.82	2.58	2.49	2.38

5A. Mailing envelopes included. Not inserted.

# NEW!

## Cards | Just Because Cards

This "Just Because" greeting card line is the perfect addition to your business stationery set. Use for staying in touch, encouragement cards, gift kit inserts, and more. Use any of our everyday sentiments for these designs.



**4053** • 5" x 7", A2, 3-½" x 5" (shown) ♻️  
**Imprint:** Printed in 1-4 Color  
**Stock:** Uncoated White



	50	75	100	500	1000
3-½" x 5"	2.49	2.26	2.05	1.99	1.84
<b>A2</b>	3.13	2.82	2.58	2.49	2.38
<b>5" x 7"</b>	3.13	2.82	2.58	2.49	2.38

5A. Mailing envelopes included. Not inserted.

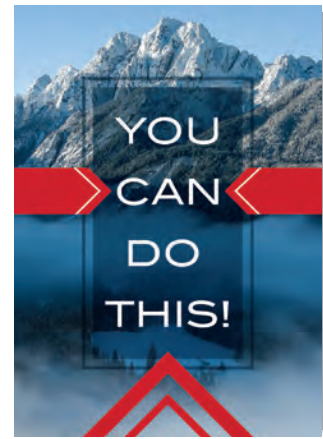

**4051** • 5" x 7" (shown), A2, 3-½" x 5" ♻️  
**Imprint:** Printed in 1-4 Color  
**Stock:** Uncoated White

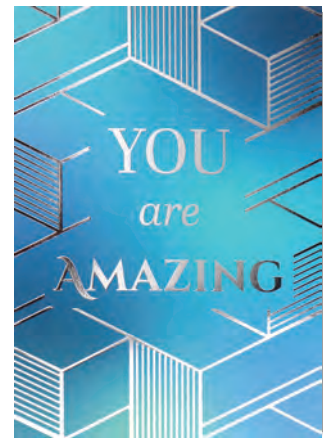

**9039** • 5" x 7"  
**Imprint:** Silver Foil  
**Stock:** Smooth White



**4054** TURQUOISE/PINK  
**4055** PURPLE/GREEN  
 5" x 7" (shown), A2, 3-½" x 5" ♻️  
**Imprint:** Printed in 1-4 Color  
**Stock:** Uncoated White



**9038** • 5" x 7"  
**Imprint:** Gold Foil  
**Stock:** Smooth White (inside is White)



**4050** • 5" x 7" (shown), A2, 3-½" x 5" ♻️  
**Imprint:** Printed in 1-4 Color  
**Stock:** Uncoated White



## Cards | Congratulations Cards & Specs



**4024** • 5" x 7" (shown), A2, 3-1/2" x 5"  
**Imprint:** Printed in 1-4 Color  
**Stock:** Smooth White



**4042** • 5" x 7", A2 (shown), 3-1/2" x 5"  
**Imprint:** Printed in 1-4 Color  
**Stock:** Smooth White



### Coordinate with packaging.

Themed, matching tuck and pillow boxes are available for select greeting cards.



Small Pillow Box  
#2000-ST

Medium Tuck Box  
#2005-MT



**8012** • 3-1/2" x 5"   
**Imprint:** Gold Foil  
**Stock:** Uncoated White



**7515** • A2 (4-1/4" x 5-1/2")  
**Imprint:** Gold Foil  
**Stock:** Smooth White



**9033** • 5" x 7"  
**Imprint:** Silver Foil  
**Stock:** Smooth White

	50	75	100	500	1000
3-1/2" x 5"	2.49	2.26	2.05	1.99	1.84
<b>A2</b>	3.13	2.82	2.58	2.49	2.38
5" x 7"	3.13	2.82	2.58	2.49	2.38

5A. Mailing envelopes included. Not inserted.

### 7510 (White), 7512 (Teal), 7511 (Black)

A2 (4-1/4" x 5-1/2")

**Imprint:** Gold Foil

**Stock:** Smooth White



## Greeting Card Specifications

### Folded Size

3-1/2" x 5", 4-1/4" x 5-1/2" (A2), or 5" x 7"  
 Shipped flat in boxed sets of 50.

### Combined Quantity Price

Available if you have a customer who would like note cards and other Warwick products.

### Custom Sentiments

Available. Please contact us for pricing.

### Imprint

Imprint color is noted by each card. Imprint colors other than standard available.

### Custom Cards

Custom greeting cards are available; please contact us for details.

### Weight

Packaged w/envelopes, 50 per box. Over 500 packed bulk.

3-1/2" x 5" – 3 lbs. per 100

4-1/4" x 5-1/2" (A2) – 5 lbs. per 100

5" x 7" – 6 lbs. per 100

### Die Cutting

Business card or photo die cuts available.

### Envelopes

Gold or Silver foil-lined envelopes come standard with all 5" x 7" holiday cards. Plain white envelopes come standard with all other cards.

Envelopes can be imprinted with return address or name on back flap as well as full-bleed, full-color print on the front side of the envelope. White Peel & Stick envelopes available. Peel & Stick envelopes \$0.20 (D) each for 5" x 7" only.

### Imprinted Envelopes

Full-color imprinting is available on all envelopes. See page 89 for details.



**BIRTHDAY**

1. *Best Wishes on Your Birthday!*
2. **With Warmest Birthday Wishes.**
3. **Wishing You the Best on Your Birthday and Always.**
23. **Wishing you a Year that's**  
*A Piece of Cake*
24. **WISHING YOU A**  
*Big Slice of HAPPINESS*  
**IN THE COMING YEAR**
25. *Best Wishes*  
on your birthday and throughout the coming year
26. **Wishing you the simple pleasures in life!**  
*Happy Birthday*

**THANK YOU**

4. *With Great Appreciation*
5. **With Sincere Thanks and Warm Wishes.**
6. **It Was Our Pleasure to Serve You.**
7. *for your referral*
27. *A note of*  
**thanks**  
*to express our sincere gratitude.*
28. **YOU'RE THE BEST Thank You!**
29. **With** *Heartfelt* **appreciation!**
30. **YOUR SUPPORT MEANS THE WORLD TO US!**  
Thanks for your business. We hope to work with you again in the future.

**CONGRATULATIONS**

8. *Congratulations and Best Wishes Always!*
9. **Congratulations! It's Celebration Time.**
10. **Enjoy your Special Day.**
31. **CONGRATULATIONS**  
on your well-deserved success
32. *Hooray!*  
**WE COULDN'T BE HAPPIER FOR YOU!**
33. **CONGRATULATIONS and BEST WISHES to you in the future!**
34. **Here's to making**  
*dreams*  
**come true**

**APPRECIATION**

11. *And Look Forward to Serving You Again.*
12. **And We Hope You'll Call on Us Again.**
13. **And Look Forward to Our Continued Relationship.**

**SYMPATHY**

14. *We would like to extend our sincerest sympathy to you and your family.*
15. **Please accept our deepest sympathy.**
16. **Our heartfelt thoughts are with you.**
35. **Wishing you** *Hope* **in the midst of your sorrow and**  
*Comfort* **amidst your pain.**
36. *Our Deepest Sympathy*  
Please accept our most sincere condolences for your loss.  
♡
37. **You are in our**  
**THOUGHTS & PRAYERS**
38. **OFFERING YOU**  
*strength, comfort, and support*  
**DURING THESE DIFFICULT DAYS.**

**ANNIVERSARY**

17. *Wishing you a wonderful day!*
18. **We appreciate your contributions to our success the past year.**
19. **Warmest wishes on your special day!**
39. **WISHING YOU ALL THE BEST ON YOUR SPECIAL DAY!**  
*Congratulations*
40. *Bravo!*  
**Thank you for your dedication.**  
*Happy Anniversary*
41. **Happy Work Anniversary!**  
It's a pleasure working with you and we look forward to celebrating your continued success.
42. *Today we celebrate*  
**your dedication and commitment to our organization and**  
*Thank you*  
**for being a part of our success!**

**WELCOME**

20. *Welcome to the Team.*
21. **Welcome, it is a pleasure to have you here.**
22. **Our entire company extends its warmest welcome.**
43. **It is a great honor to have you on our team.**  
**CONGRATULATIONS & WELCOME.**
44. **A warm welcome and lots of good wishes on becoming part of our growing team!**
45. **Congratulations on being part of the team!**
- Welcome Aboard**
46. **We are delighted to have you with us and look forward to your future success.**

Interested in

*custom*

sentiments?

.....  
We'd love to help you create the unique greeting card you're looking for.

See p. 86 for details or get in touch with your rep to talk custom sentiments.



Cards | 5" x 7" Holiday Cards



**5756 CHRISTMAS STAG** ♻️

**Imprint:** Gold Foil  
**Stock:** Green Linen (inside is Green)  
 PREMIUM CARD



**5733 PINE HOLIDAY GREETINGS** ♻️

**Imprint:** Silver Foil  
**Stock:** Uncoated White  
 CLASSIC CARD



**5721 FILIGREE SNOWFLAKE** ♻️

**Imprint:** Gold Foil  
**Stock:** Navy Linen (inside is Navy)  
 PREMIUM CARD



**5727 BRUSHSTROKE TREE** ♻️

**Imprint:** Gold Foil  
**Stock:** Ivory Linen (inside is Ivory)  
 PREMIUM CARD

	50	75	100	500	1000
<b>CLASSIC</b>	<b>50</b>	<b>75</b>	<b>100</b>	<b>500</b>	<b>1000</b>
By 10/1	2.88	2.59	2.37	2.29	2.19
After 10/1	3.13	2.82	2.58	2.49	2.38
<b>PREMIUM</b>	<b>50</b>	<b>75</b>	<b>100</b>	<b>500</b>	<b>1000</b>
By 10/1	3.26	2.94	2.77	2.65	2.55
After 10/1	3.54	3.19	3.01	2.88	2.77

5A. Mailing envelopes included. Not inserted.



**5759 WINTER BARN** ♻️

**Imprint:** Printed in 1-4 Color  
**Stock:** White Felt  
 PREMIUM CARD



**5761 REJOICE** ♻️

**Imprint:** Printed in 1-4 Color  
**Stock:** Uncoated White  
 CLASSIC CARD





**5726** HOPE, PEACE, JOY & CHEER

**Imprint:** Silver Foil

**Stock:** Smooth White (*inside is White*)

**CLASSIC CARD**



**5716** CHRISTMAS RIBBON 

**Imprint:** Gold Foil

**Stock:** White Linen

**PREMIUM CARD**



**5750** MERRY CHRISTMAS TREE

**Imprint:** Printed in 1-4 Color

**Stock:** Pearlescent

**PREMIUM CARD**



**5758** HOLLY GREETINGS 

**Imprint:** Printed in 1-4 Color

**Stock:** White Felt

**PREMIUM CARD**



**5580** SNOWFLAKES WREATH 

**Imprint:** Silver Foil

**Stock:** Black Felt (*inside is Black*)

**PREMIUM CARD**



**5712** DESIGNER TREE

**Imprint:** Silver Foil

**Stock:** Pearlescent

**PREMIUM CARD**



**5757** HAPPY PAWLIDAYS 

**Imprint:** Printed in 1-4 Color

**Stock:** White Felt

**PREMIUM CARD**



**5736** WINTER WISHES

**Imprint:** Silver Foil

**Stock:** Smooth White

**CLASSIC CARD**

See more Holiday Cards!

Visit our website to view our entire Holiday Card Collection. And be sure to request our Holiday Card Catalog!

Award-winning promotional products supplier

Cards | 5" x 7" Holiday Cards



**5752 COMFORT & JOY**  
**Imprint:** Gold Foil  
**Stock:** Smooth White  
**CLASSIC CARD**



**5751 MERRY CHRISTMAS TO YOU**  
**Imprint:** Printed in 1-4 Color  
**Stock:** Smooth White  
**CLASSIC CARD**



CLASSIC	50	75	100	500	1000
By 10/1	2.88	2.59	2.37	2.29	2.19
After 10/1	3.13	2.82	2.58	2.49	2.38
PREMIUM	50	75	100	500	1000
By 10/1	3.26	2.94	2.77	2.65	2.55
After 10/1	3.54	3.19	3.01	2.88	2.77

5A. Mailing envelopes included. Not inserted.



**5760 O HOLY NIGHT**  
**Imprint:** Silver Foil  
**Stock:** Smooth White  
**CLASSIC CARD**



**5575 SNOW COVERED TREES**  
**Imprint:** Silver Foil  
**Stock:** Smooth White (inside is White)  
**CLASSIC CARD**

**5762 HAPPY NEW YEAR CHAMPAGNE**  
**Imprint:** Gold Foil  
**Stock:** Smooth White  
**CLASSIC CARD**



**5745 CLASSIC CHEERS**  
**Imprint:** Silver Foil  
**Stock:** Smooth White  
**CLASSIC CARD**



1. *Season's Greetings and Best Wishes  
for the New Year.*
2. To Our Friends and Customers,  
Our Warmest Wishes for a  
Joyous Holiday Season and a New Year  
Filled with Peace and Happiness.
3. *May the Joy and Peace  
of Christmas  
Be Yours Today and Always.*
4. *Best Wishes  
for a Joyous Holiday.*
5. Our Entire Company  
Extends Our Warmest Wishes  
for a Joyous Holiday Season  
and a Happy New Year.
6. **Happy Hanukkah!**
7. *Wishing you prosperity,  
health and happiness  
on this special day of thanks.*
8. Sending Warm Wishes  
This Thanksgiving Season and  
Throughout the Coming Holidays.
9. Extending Special Wishes  
for a happy, healthy and  
prosperous New Year.
10. Wishing you all the best  
in the coming year.
11. *To Our Friends and Customers,  
Our Warmest Wishes for a  
Joyous Holiday Season and a New Year  
Filled with Peace and Happiness.*
12. *Best Wishes  
for a Joyous Holiday.*
13. *Merry Christmas  
and a  
Happy New Year.*
14. *Wishing You a Beautiful  
Holiday Season and a New Year  
of Peace and Happiness.*
15. *Felices Fiestas  
y Próspero Año Nuevo*
16. **Peace and Joy  
Throughout the Season**
17. This Holiday Season  
We Extend Our Thanks,  
and Wish You  
Peace and Happiness.

18. **Peace on Earth  
Good Will to All**
19. *Best Wishes  
for a  
Prosperous New Year!*
20. **We Wish You  
a Merry Christmas  
& a Joyous New Year!**
21. **HAPPY HOLIDAYS**  
*Wishing you every happiness this  
holiday season & throughout the coming year.*
22. *We extend our  
Warmest Wishes for the Holiday Season  
to our clients and friends.  
Thank you for your continued support.  
Happy Holidays!*
23. *Candy Canes and  
Holiday Cheer  
are things that we adore, but  
wishing you a Merry Christmas  
is something we love more!*
24. *Wishing you and your family  
lots of good health,  
tons of happiness & plenty of prosperity  
in the year ahead.  
Happy New Year!*
25. *Good Tidings  
to you and your loved ones this  
Holiday Season  
and the whole year through.*
26. *May the  
Magic and Wonder  
of the Season  
Fill your Heart and Home.  
Happy Holidays*
27. *Wishing you all the  
Hope, Wonder, and Joy  
that the Season can bring!*

28. *MAY ALL THE JOYS OF CHRISTMAS  
FILL YOUR HEART THROUGHOUT THE NEW YEAR*
29. *Wishing you every happiness  
this Holiday Season and  
throughout the coming year!*
30. *Wishing you a  
**NEW YEAR**  
filled of good health, much happiness,  
and plenty of prosperity.*
31. *Thank You*  
FOR HELPING MAKE THIS A TRULY ENJOYABLE,  
SUCCESSFUL, AND FULFILLING YEAR.  
BEST WISHES FOR THE NEW YEAR!
32. *A toast  
to you and yours in the New Year.*
33. *Let your home be  
filled with the warmth  
of loved ones  
this Thanksgiving!*
34. *May your  
heart and plate be full  
on Thanksgiving Day and  
each day thereafter!*
35. *Wishing you and your family a  
Thanksgiving full of  
joy, laughter, and good food.  
Happy Thanksgiving!*
36. **May** the good things of life  
be yours in abundance  
not only at Thanksgiving,  
but throughout the coming year.
37. *Wishing you a  
Thanksgiving stuffed  
with lots of fun and family!*
38. *May the many blessings of  
Thanksgiving  
bring you an outpouring of  
love and warmth.  
Happy Thanksgiving  
to you and yours.*



**Need envelopes? They're included!**

We include Silver or Gold foil-lined envelopes with every holiday card order. Lining coordinates with imprint color.

**NEW!**



**4057** HAPPY HANUKKAH

**Imprint:** Printed in 1-4 Color

**Stock:** Smooth White

**CLASSIC CARD**



**4059** SHANA TOVA DOVE

**Imprint:** Printed in 1-4 Color

**Stock:** Smooth White

**CLASSIC CARD**



**4060** SHANA TOVA POMEGRANATE

**Imprint:** Printed in 1-4 Color

**Stock:** Uncoated White

**CLASSIC CARD**



**4058** STAR OF DAVID

**Imprint:** Printed in 1-4 Color

**Stock:** Smooth White

**CLASSIC CARD**



**4061** SWEET NEW YEAR

**Imprint:** Printed in 1-4 Color

**Stock:** Uncoated White

**CLASSIC CARD**



6. Happy Hanukkah!

39. *Wishing you a joyous Festival of Lights filled with warmth and love.*

40. *Happy Hanukkah!*  
*May the spirit of this season bring you peace and happiness.*

41. *Happy Rosh Hashanah!*  
Wishing you a happy and healthy new year.

42. *L'shanah tovah tikatevu v'techatemu*

43. *Shanah Tovah!*

	50	75	100	500	1000
<b>CLASSIC</b>					
By 10/1	2.88	2.59	2.37	2.29	2.19
After 10/1	3.13	2.82	2.58	2.49	2.38
<b>PREMIUM</b>					
By 10/1	3.26	2.94	2.77	2.65	2.55
After 10/1	3.54	3.19	3.01	2.88	2.77

5A. Mailing envelopes included. Not inserted.

**Email Artwork to**  
**artwork@wpcpp.com**  
*(compressing in a ZIP file)*

**Preferred Applications**  
 Adobe® Illustrator®  
 Adobe® Photoshop®  
 Adobe® InDesign®

**Digital File Formats**

We prefer Illustrator vector art. Accepted file formats include EPS, press-quality AI, PDF, TIFF, JPG, and PSD. Please keep layered Photoshop files intact. We also accept:

**Photos:** Send photos in TIFF format and scanned in at 300DPI at full size.

**Line Art:** Art should be created in a vector art-based program such as Illustrator. If this is not possible, submit a TIFF scan at 600DPI or higher.

**Vector Art:** Vector art is made up of curves and points and has no placed or raster graphics.

**Raster Art:** Raster art is made up of tiny boxes and arranged on pixels per inch (PPI, many refer to this as DPI). We prefer that all raster images come to us at a resolution of 600–1200DPI at printed size.

**Art Charges:** Cleanup of artwork will incur an additional charge of \$81.60 (D) per hour with a minimum charge of 1 hour.

**Color**

We only use CMYK/spot color space, not RGB. All single-color jobs should be provided to us in black and white. All multi-colored jobs should be sent in vector format with the appropriate spot/process color selected.

**Fonts**

When creating art, please create outlines in Illustrator for your fonts or send the full font for printing purposes.

**The Use of Web Art**

Artwork used on the internet is meant for viewing only. The images on websites have been saved at 72DPI and are not intended to be printed. We cannot accept these images for print reproduction.

**Artwork Hints & Tips**

High-resolution artwork will produce the best imprint quality. Here are some easy and helpful hints for creating high-resolution art:

**InDesign Hints**

Specify all colors as PMS spot colors or CMYK; exactly the way you want them printed. Keep images at 100% whenever possible to avoid changes or errors.

**Illustrator Hints**

Use CMYK color code and specify your colors either as PMS spot colors or CMYK to ensure that you get the colors you are expecting.

**Photoshop Hints**

Please send black and white art files at the size they are to be printed. Resolution should be 600–1200DPI. Continuous Tone Images should be at 300DPI and at the correct sizes to be printed. Lower resolutions may result in loss of quality.

**Acrobat Hints**

Please submit file exactly as it is to be used for positioning, size, colors, and bleeds. Fonts should be outlined before making the PDF file whenever possible.

**Art Solutions**

Warwick has a fully-staffed Art Department with many years of experience to help you. If you cannot supply us with satisfactory art, we may be able to assist you. Please call Customer Service for assistance. Art charges may apply.

**Additional Colors/Locations**

*Excludes: Easy Sticks, Value Sticks, and Pocket Folders; see product pages.*

# of Colors	150	250	500	1000	1750	2500
2 Color/Location	0.61	0.46	0.35	0.28	0.27	0.26
3 Color/Location	1.22	0.94	0.69	0.56	0.53	0.50
4 Color/Location	1.85	1.40	1.03	0.84	0.80	0.75

6D. Above prices are for **Spot Colors** only. *150 minimum for 2 or more colors.*

**Imprinted Envelopes (Minimum 150, full-color)**

Location	150	250	500	1000
Flap	0.40	0.33	0.27	0.25
Front	0.45	0.38	0.32	0.30

4D. Envelopes can be imprinted with return address, name, and/or logo in 1–4 colors. Unless otherwise specified, standard imprint color is black. PMS color matching is not offered. Color will match as close as possible. Calendar envelopes are imprinted on the front. Greeting card envelopes are imprinted on the back (unless noted on order to imprint on front). Please follow post office regulations if you intend on mailing the envelopes as a stand-alone. Warwick will not be responsible for "un-mailable" ad copy.

**Email Purchase Orders to**  
**orders@wpcpp.com**  
*(do not send POs to artwork email)*

**Media**  
 USB Drive

**Emailed Art Must Include:**

- Your Company Name
- Phone Number
- PO#
- Contact Person

Unless a specific layout is requested, copy will be set to compliment the product. Artwork is kept on file for a period of one calendar year.

**Login to our FTP site**

file.warwickpublishing.com

**Download Images**

Username: image Password: warwick

**Download Templates**

Username: template Password: warwick

**Upload Art**

Username: upload Password: warwick

**Foil Stamping Guide**

Foil stamping is a combination of heat and pressure along with an etched magnesium plate to seal in your foil imprint. For the highest quality stamp, send in black and white line art. Please note that foil stamping may cause fine detail or screens to fill in and change your image.



**Bad Artwork**  
 This logo includes shading and beveled edges, which we cannot foil stamp.



**Good Artwork**  
 Good art includes no fine lines, shading, or screens.

**Acetate Protectors (Certificates)**

Clear acetate protectors are available for some certificate holders at \$0.50 (D) each. See item description for availability.

**C.O.D. Shipments**

Not available.

**Copy Change – Calendars, Frames, Cards & Pouches**

\$33.66 (D) per change. Minimum quantity copy change on calendars and frames is 150. Minimum quantity per copy change on cards is 50. Includes drop shipment.

**Copy Change – Foil Stamped Folders**

Orders requesting the same item with changes of copy qualify for the quantity price with a set-up charge. Folders \$62.22 (C) per color/location up to 30 square inches. Over 30 square inches \$130.56 (C) per color/location.

**Change of copy is NOT available for ink offset presentation folders.**

**Drop Shipments**

\$12.40 (D) per drop shipment. Minimum quantities per drop shipment may apply based on product. Drop shipments may increase lead time.

**Early/Late Release**

If a shipping date is changed (earlier or later) after the order has been placed into storage and it is necessary to remove it from storage, a \$52.02 (D) charge will apply.

**Embossing (Pocket Folders and Cards Only)**

Single-level embossing is available. Please send art for price quote and lead time. Fine detail is not recommended. Not available on Budget Folders.

**Factory Ready**

An order is factory ready when all copy information, clean artwork, style, color, quantity, approved proof, etc. has been received and the order is ready for production. Orders must be ready by June 1 (calendars) or October 1 (holiday cards) to receive early order pricing.

# Info | General Information

## Foil Pricing

Foil is priced per ad area as indicated for each item. Larger foil imprint may be charged as additional color/location. Screens, small type sizes, fine detail, or tight registration not recommended.

## Freight

F.O.B. Factory. Freight is additional. Not responsible for delayed shipments when given to the carrier on time. Unless carrier is specified, we will ship UPS Ground, FedEx Ground, or equivalent carrier based upon time, destination, and weight.

## Less Than Minimum

Orders for less than minimum quantity: \$54.06 (D) per copy change. Absolute minimum on Value Stick™ and Easy Stick™ calendars is 150. Absolute minimum on Foil Imprinted Folders is 150. Absolute minimum on Printed Folders is 250.

## Order Changes or Cancellations

Changes and cancellations do occur and will be made at no charge is done before imprinting. Changes and cancellations made after imprinting has started will be billed at cost.

## Order & Shipping Acknowledgments

When requested, we will send acknowledgments via email. Paper acknowledgments are not mailed. Please review the acknowledgments and contact us immediately with any corrections or changes.

## Overruns/Underruns

Billing will be for the actual amount of units shipped. Overruns or Underruns will be within 10% of the quantity ordered. Orders calling for "No Overruns" are subject to a short shipment.

## Self Promos (PSAs)

Contact customer service for pricing. Self promo orders will ship when ready and do not take priority over end user orders, especially after September 1.

## Returns

A 20% restocking fee will apply to all returned products (non-imprinted products only). Prior approval is required. Damaged goods will not be refunded.

## Split Pads

Not available.

## Sales Tax

Unless we have a tax exemption certificate on file for you, we are required to charge applicable sales tax on orders shipping into the following states:

- |                      |                 |                   |                |
|----------------------|-----------------|-------------------|----------------|
| • Arkansas*          | • Illinois      | • Minnesota*      | • S. Carolina* |
| • Arizona            | • Indiana*      | • Missouri        | • S. Dakota*   |
| • California         | • Iowa          | • Nebraska*       | • Tennessee*   |
| • Colorado           | • Kansas*       | • Nevada          | • Texas*       |
| • Connecticut*       | • Kentucky*     | • New Jersey*     | • Utah         |
| • Dist. of Columbia* | • Louisiana*    | • New York*       | • Vermont*     |
| • Florida            | • Maine         | • North Carolina* | • Virginia     |
| • Georgia*           | • Maryland      | • Ohio            | • Washington*  |
| • Hawaii*            | • Massachusetts | • Oklahoma        | • W. Virginia* |
| • Idaho              | • Michigan      | • Pennsylvania*   | • Wisconsin*   |

\* = FREIGHT IS ALSO TAXED

## Shipping

Address correction charges will be billed. All ground shipments require a complete street address. If only a P.O. Box is provided, order will ship Parcel Post (will be shipped Parcel Post insured). We suggest expedited shipping methods on orders being shipped outside the continental United States, for better service and tracking. Warwick will not be responsible for Parcel Post shipments after September 1. Shipping and handling charges are prepaid and added to your invoice. Labels are computer generated with distributor's return address.

**3rd party shipments: \$5.00 (X) per shipment.**

## Special Imprint Colors

Items in this catalog shown with standard imprint colors. Imprints other than standard are \$39.78 (D). If PMS color must be matched \$62.22 (D). Exact color matches not available on Easy Stick Calendars, Value Stick Calendars, or digitally printed items.

## Substitution

May be necessary due to possible stock shortages late in the ordering season. If substitution is not permitted, the order must clearly state "no substitution".

## Shipping Packaging Guarantee

Warwick provides, as individual SKUs, custom printed corrugated packaging deemed fit for shipping without secondary packaging. However, due to the custom nature of this packaging, Edge Crush Test certification is not available for these SKUs. Additionally, due to the less-than-careful nature of freight and shipping providers, it is expected that the print on corrugated packaging and the corners/raised edges of this packaging will experience normal wear and tear during transit to the package's final destination. For this reason, damage to packaging for order refund/credit/replacement must be reported prior to shipment. Damage reported after shipping will not be considered for credit or replacement.

## Proofs

**All Items:** Emailed proofs at no charge for the first proof. The charges for multiple proofs of customer changes is \$26.52 (D) each.

## Finished Product Proof

**All Calendars (except Daily Date):** \$53.04 (D) per color.

**Frames & Cards:** \$53.04 (D) per color.

**Stock Document Pouches:** \$53.04 (D) per color.

**Custom Document Pouches:** Call for quotation.

**Stamped Pocket Folders:** \$62.22 (C) per color/location up to 30 sq. ins.

**Stamped Pocket Folders:** \$131.58 (C) per color/location over 30 sq. ins.

**Printed Pocket Folders:** Product proof not available.

**Corrugated Boxes & Yard Signs:** \$50 (A)

**Digital Epson proof only:** \$130.00 (D)

*Please call for quotation on custom items.*

Proofs are sent only when requested on the purchase order, and are only sent by email to the address(es) on the purchase order. Proofs can and will delay shipment. Signed proofs must be returned before order is considered ready for production and standard lead times take effect. Credit will not be issued on errors after the factory has received final approval.

## Kitting, Fulfillment, and Warehousing

Kitting jobs are priced by required touch at \$0.20 (X) each on a project plus a flat fee \$0.35 (X) for labeling and final shipping coordination. A touch is defined by both the number of items involved in a kit as well as the number of manipulations required to perform on an item for it to be ready for packing into a kit. Such examples include but are not limited to: Folding or Unfolding, Unwrapping, Sticker Removal or Application of Stickers, Tag Removal or Tag Application, Inserting, Spraying, Assembly, or any other action that deviates from a normal pick and pack process as-received by the warehousing team. Warwick reserves the right to back-bill for improper communication of kitting and packing requirements if not communicated clearly at time of quoting or purchase order receipt and review.

Warwick cannot control the actions of shipping and logistics providers once a kitted package leaves our production facility. Additionally, Warwick cannot control or guarantee the quality of products supplied by any 3rd party supplier that we did not source directly ourselves through Warwick's purchasing operations. As such, Warwick is not responsible for damage experienced during transit to any internal kitted components and will not reimburse or refund for damages that incurred to internal components during transit. If a Warwick-manufactured product is damaged during transit, our normal refund and returns policy will apply.

Warwick provides Warehousing and on-demand Fulfillment services as part of our operations. Warehousing pricing is \$20 (X) per skid, per month, and warehouse space is not climate controlled. Fulfillment services are quoted on a per-job basis.

Warwick will not kit, fulfill, or ship any of the following classes of materials: Hazardous Materials, Pharmaceutical or Medical Materials that are not readily and generally available to the public without prior approval, Drugs or other controlled substances that are not federally legal in all 50 States and all Territories, or anything that requires climate controlling to prevent spoilage. Additionally, Warwick may decline to ship a class of material without notice if it would go against the spirit of this policy, even if the substance class is not explicitly listed above. Warwick also reserves the right to decline to quote or cancel an existing order without notice if asked to kit, fulfill, or ship anything that is deemed against this policy or is shipped product that is deemed against this policy. Warwick is not responsible for costs incurred in any capacity in this instance, including declined delivery charges, temporary storage charges, handling charges, and/or disposal charges of something delivered to our facility in violation of this policy.

## Outdoor Signage

Signage sold by Warwick is manufactured with state-of-the-art printing technology. Even so, natural fading and discoloration is not 100% preventable and may vary based on the usage destination of the signage. Because of this, only excessive, rapid discoloration outside of normal expected wear and tear of outdoor use will be eligible for refund/credit/replacement.

Signage that should not be displayed outdoors is marked clearly as indoor signage on SKU information pages and will not be credited in any way for natural fading or discoloration.



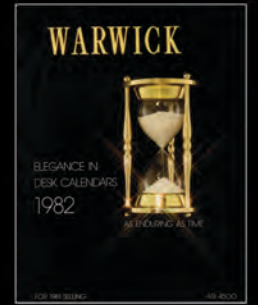

# CELEBRATING 100 YEARS OF MAKING PAPER PERFORM

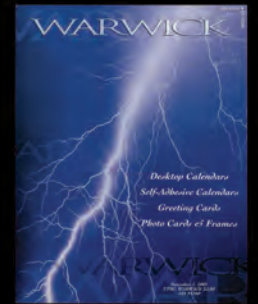
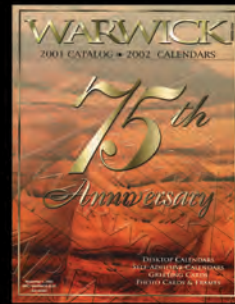
Family owned and operated since 1926 • Manufactured in the USA  
© Warwick 2026 All Rights Reserved